

spex

Shaping Better Lives



CLINICAL WHEELCHAIR SEATING

SCRIPTING AND ORDERING GUIDE

Spex Seat Base

BASE PACKAGE:

- Single piece seat base plate
- Either Quick-Release or Fixed-Mount hardware set
- Pair of retainer brackets

Weight: 2.4kg for Seat Base with Quick-Release, 2.3kg for Seat Base with Fixed Mount (16x18" 40x45cm)



2. SELECT HARDWARE

Fixed-Mount



1008-WWLL-FXB

Quick-Release



1008-WWLL-QRB

1. SELECT SIZE

WIDTH	LENGTH	CODE	✓
10" 25cm	12" 30cm	1008-1012-XXX	<input type="radio"/>
	14" 36cm	1008-1014-XXX	<input type="radio"/>
12" 30cm	12" 30cm	1008-1212-XXX	<input type="radio"/>
	14" 35cm	1008-1214-XXX	<input type="radio"/>
	16" 40cm	1008-1216-XXX	<input type="radio"/>
14" 35cm	18" 45cm	1008-1218-XXX	<input type="radio"/>
	14" 35cm	1008-1414-XXX	<input type="radio"/>
	16" 40cm	1008-1416-XXX	<input type="radio"/>
15" 38cm	18" 45cm	1008-1418-XXX	<input type="radio"/>
	17" 43cm	1008-1517-XXX	<input type="radio"/>
16" 40cm	20" 50cm	1008-1520-XXX	<input type="radio"/>
	16" 40cm	1008-1616-XXX	<input type="radio"/>
	18" 45cm	1008-1618-XXX	<input type="radio"/>
17" 43cm	20" 50cm	1008-1620-XXX	<input type="radio"/>
	22" 55cm	1008-1622-XXX	<input type="radio"/>
	17" 43cm	1008-1717-XXX	<input type="radio"/>
18" 45cm	20" 50cm	1008-1720-XXX	<input type="radio"/>
	22" 55cm	1008-1722-XXX	<input type="radio"/>
	18" 45cm	1008-1818-XXX	<input type="radio"/>
20"	20" 50cm	1008-1820-XXX	<input type="radio"/>
	22" 55cm	1008-1822-XXX	<input type="radio"/>
	20" 50cm	1008-2020-XXX	<input type="radio"/>
22" 55cm	22" 55cm	1008-2022-XXX	<input type="radio"/>
	22" 55cm	1008-2222-XXX	<input type="radio"/>
Up to 20" 50cm	XX = ----	1008-2929-XXX	<input type="radio"/>
Up to 25" 63cm	XX = ----	1008-2939-XXX	<input type="radio"/>

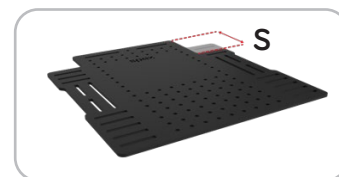
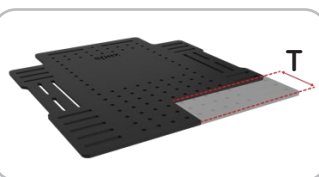

3. CUSTOMISE (IF REQUIRED)

✓	ITEM	NOTES
<input type="radio"/>	Leg Length Discrepancy Available in 1" Increments 1008-0292-000	<div style="border: 1px solid red; padding: 2px; display: inline-block;">SELECT</div> <input type="radio"/> L <input type="radio"/> R T = <input type="text" value="XX"/>
<input type="radio"/>	Custom backrest cane depth cut-outs Up to 2" additional depth, available in 1" Increments Standard Cut-Out = 3"x3" (8x8cm) 1008-0291-000	S = <input type="text" value="XX"/>
<input type="radio"/>	Additional Cushion retainer bracket (pair) Note: All bases come with a pair of cushion retainers 1008-0250-100	

WHEELCHAIR COMPATIBILITY

Seat Base Width
10" - 20"

Seat Base Width
21" +

Fixed Mount

-0" to +2"

-0" to +1"

Quick Release

-1 to +2"

-1 to +1"

Vigour Standard Contour Cushion

1. SELECT SIZE

WIDTH	LENGTH	CODE	✓
8" 20cm	8" 20cm	1103-0808-OSC	<input type="radio"/>
	10" 25cm	1103-0810-OSC	<input type="radio"/>
10" 25cm	10" 25cm	1103-1010-OSC	<input type="radio"/>
	12" 30cm	1103-1012-OSC	<input type="radio"/>
	XX XX	1103-10XX-OSC	<input type="radio"/>
11" 28cm	10" 25cm	1103-1110-OSC	<input type="radio"/>
	12" 30cm	1103-1112-OSC	<input type="radio"/>
	XX XX	1103-11XX-OSC	<input type="radio"/>
12" 30cm	12" 30cm	1103-1212-OSC	<input type="radio"/>
	14" 35cm	1103-1214-OSC	<input type="radio"/>
	XX XX	1103-12XX-OSC	<input type="radio"/>
13" 33cm	12" 30cm	1103-1312-OSC	<input type="radio"/>
	14" 35cm	1103-1314-OSC	<input type="radio"/>
	XX XX	1103-13XX-OSC	<input type="radio"/>
14" 35cm	14" 35cm	1103-1414-OSC	<input type="radio"/>
	16" 40cm	1103-1416-OSC	<input type="radio"/>
	18" 45cm	1103-1418-OSC	<input type="radio"/>
	XX XX	1103-14XX-OSC	<input type="radio"/>
15" 38cm	14" 35cm	1103-1514-OSC	<input type="radio"/>
	16" 40cm	1103-1516-OSC	<input type="radio"/>
	XX XX	1103-15XX-OSC	<input type="radio"/>
16" 40cm	16" 40cm	1103-1616-OSC	<input type="radio"/>
	18" 45cm	1103-1618-OSC	<input type="radio"/>
	20" 50cm	1103-1620-OSC	<input type="radio"/>
17" 43cm	XX XX	1103-16XX-OSC	<input type="radio"/>
	17" 43cm	1103-1717-OSC	<input type="radio"/>
	18" 45cm	1103-1718-OSC	<input type="radio"/>
18" 45cm	XX XX	1103-17XX-OSC	<input type="radio"/>
	18" 45cm	1103-1818-OSC	<input type="radio"/>
	20" 50cm	1103-1820-OSC	<input type="radio"/>
19" 48cm	22" 55cm	1103-1822-OSC	<input type="radio"/>
	XX XX	1103-18XX-OSC	<input type="radio"/>
	18" 45cm	1103-1918-OSC	<input type="radio"/>
20" 50cm	20" 50cm	1103-1920-OSC	<input type="radio"/>
	22" 55cm	1103-1922-OSC	<input type="radio"/>
	XX XX	1103-19XX-OSC	<input type="radio"/>
22" 55cm	18" 45cm	1103-2018-OSC	<input type="radio"/>
	20" 50cm	1103-2020-OSC	<input type="radio"/>
	22" 55cm	1103-2022-OSC	<input type="radio"/>
24" 60cm	XX XX	1103-20XX-OSC	<input type="radio"/>
	18" 45cm	1103-2218-OSC	<input type="radio"/>
	20" 50cm	1103-2220-OSC	<input type="radio"/>
Up to 20" 50cm	22" 55cm	1103-2222-OSC	<input type="radio"/>
	18" 45cm	1103-2418-OSC	<input type="radio"/>
Up to 25" 63cm	20" 50cm	1103-2420-OSC	<input type="radio"/>
	22" 55cm	1103-2422-OSC	<input type="radio"/>
	XX = _ _ _ _	1103-2929-OSC	<input type="radio"/>
	XX = _ _ _ _	1103-2939-OSC	<input type="radio"/>

PACKAGE INCLUDES:

- Outer Cover
- Incontinence Cover
- Cushion Foam Unit



TROUGH HEIGHT = 3CM

2. SELECT COLOUR

Your colour selection applies to any extra covers ordered

Black (default)	Chilli 1209-2491-022	Mango 1209-2491-030
Bumblebee 1209-2491-044	Calypso 1209-2491-028	Royal 1209-2491-077
Ocean 1209-2491-060	Leaf 1209-2491-054	Granite 1209-2491-090

3. SELECT ACCESSORIES

✓	ACCESSORY	IMAGE
<input type="radio"/>	Extra Outer Cover (A) 1123-WWDD-6SC (insert width and depth relevant to cushion size)	
<input type="radio"/>	Extra Incontinence Cover (B) 1133-WWDD-7SC (insert width and depth relevant to cushion size)	
<input type="radio"/>	Rigidiser Base Panel 1110-WWDD-200 (can be inserted inside cover for a rigid surface)	
<input type="radio"/>	5° Wedge 1209-2724-300	

4. CUSTOMISE

Refer to Cushion Customisations (page 10).

Vigour High Contour Cushion

1. SELECT SIZE

WIDTH	LENGTH	CODE	✓
8" 20cm	8" 20cm	1103-0808-OHC	<input type="radio"/>
	10" 25cm	1103-0810-OHC	<input type="radio"/>
10" 25cm	10" 25cm	1103-1010-OHC	<input type="radio"/>
	12" 30cm	1103-1012-OHC	<input type="radio"/>
	XX XX	1103-10XX-OHC	<input type="radio"/>
11" 28cm	10" 25cm	1103-1110-OHC	<input type="radio"/>
	12" 30cm	1103-1112-OHC	<input type="radio"/>
	XX XX	1103-11XX-OHC	<input type="radio"/>
12" 30cm	12" 30cm	1103-1212-OHC	<input type="radio"/>
	14" 35cm	1103-1214-OHC	<input type="radio"/>
	XX XX	1103-12XX-OHC	<input type="radio"/>
13" 33cm	12" 30cm	1103-1312-OHC	<input type="radio"/>
	14" 35cm	1103-1314-OHC	<input type="radio"/>
	XX XX	1103-13XX-OHC	<input type="radio"/>
14" 35cm	14" 35cm	1103-1414-OHC	<input type="radio"/>
	16" 40cm	1103-1416-OHC	<input type="radio"/>
	18" 45cm	1103-1418-OHC	<input type="radio"/>
	XX XX	1103-14XX-OHC	<input type="radio"/>
15" 38cm	14" 35cm	1103-1514-OHC	<input type="radio"/>
	16" 40cm	1103-1516-OHC	<input type="radio"/>
	XX XX	1103-15XX-OHC	<input type="radio"/>
16" 40cm	16" 40cm	1103-1616-OHC	<input type="radio"/>
	18" 45cm	1103-1618-OHC	<input type="radio"/>
	20" 50cm	1103-1620-OHC	<input type="radio"/>
17" 43cm	XX XX	1103-16XX-OHC	<input type="radio"/>
	17" 43cm	1103-1717-OHC	<input type="radio"/>
	18" 45cm	1103-1718-OHC	<input type="radio"/>
18" 45cm	XX XX	1103-17XX-OHC	<input type="radio"/>
	18" 45cm	1103-1818-OHC	<input type="radio"/>
	20" 50cm	1103-1820-OHC	<input type="radio"/>
19" 48cm	22" 55cm	1103-1822-OHC	<input type="radio"/>
	XX XX	1103-18XX-OHC	<input type="radio"/>
	18" 45cm	1103-1918-OHC	<input type="radio"/>
20" 50cm	20" 50cm	1103-1920-OHC	<input type="radio"/>
	XX XX	1103-19XX-OHC	<input type="radio"/>
	18" 45cm	1103-2018-OHC	<input type="radio"/>
22" 55cm	20" 50cm	1103-2020-OHC	<input type="radio"/>
	22" 55cm	1103-2022-OHC	<input type="radio"/>
	XX XX	1103-20XX-OHC	<input type="radio"/>
24" 60cm	18" 45cm	1103-2218-OHC	<input type="radio"/>
	20" 50cm	1103-2220-OHC	<input type="radio"/>
	22" 55cm	1103-2222-OHC	<input type="radio"/>
Up to 20" 50cm	18" 45cm	1103-2418-OHC	<input type="radio"/>
	20" 50cm	1103-2420-OHC	<input type="radio"/>
	22" 55cm	1103-2422-OHC	<input type="radio"/>
Up to 25" 63cm	XX = _ _ _ _	1103-2929-OHC	<input type="radio"/>
	XX = _ _ _ _	1103-2939-OHC	<input type="radio"/>

PACKAGE INCLUDES:

- Outer Cover
- Incontinence Cover
- Cushion Foam Unit



TROUGH HEIGHT = 5CM

2. SELECT COLOUR

Your colour selection applies to any extra covers ordered

Black (default)	Chilli 1209-2491-022	Mango 1209-2491-030
Bumblebee 1209-2491-044	Calypso 1209-2491-028	Royal 1209-2491-077
Ocean 1209-2491-060	Leaf 1209-2491-054	Granite 1209-2491-090

3. SELECT ACCESSORIES

✓	ACCESSORY	IMAGE
<input type="radio"/>	Extra Outer Cover (A) 1123-WWDD-6HC (insert width and depth relevant to cushion size)	
<input type="radio"/>	Extra Incontinence Cover (B) 1133-WWDD-7HC (insert width and depth relevant to cushion size)	
<input type="radio"/>	Rigidiser Base Panel 1110-WWDD-200 (can be inserted inside cover for a rigid surface)	
<input type="radio"/>	5° Wedge 1209-2724-300	

4. CUSTOMISE

Refer to Cushion Customisations (page 10).

Spex Standard Contour Cushion

1. SELECT SIZE

WIDTH	LENGTH	CODE	✓
8" 20cm	8" 20cm	1105-0808-OSC	<input type="radio"/>
	10" 25cm	1105-0810-OSC	<input type="radio"/>
10" 25cm	10" 25cm	1105-1010-OSC	<input type="radio"/>
	12" 30cm	1105-1012-OSC	<input type="radio"/>
	XX XX	1105-10XX-OSC	<input type="radio"/>
11" 28cm	10" 25cm	1105-1110-OSC	<input type="radio"/>
	12" 30cm	1105-1112-OSC	<input type="radio"/>
	XX XX	1105-11XX-OSC	<input type="radio"/>
12" 30cm	12" 30cm	1105-1212-OSC	<input type="radio"/>
	14" 35cm	1105-1214-OSC	<input type="radio"/>
	XX XX	1105-12XX-OSC	<input type="radio"/>
13" 33cm	12" 30cm	1105-1312-OSC	<input type="radio"/>
	14" 35cm	1105-1314-OSC	<input type="radio"/>
	XX XX	1105-13XX-OSC	<input type="radio"/>
14" 35cm	14" 35cm	1105-1414-OSC	<input type="radio"/>
	16" 40cm	1105-1416-OSC	<input type="radio"/>
	18" 45cm	1105-1418-OSC	<input type="radio"/>
	XX XX	1105-14XX-OSC	<input type="radio"/>
15" 38cm	14" 35cm	1105-1514-OSC	<input type="radio"/>
	16" 40cm	1105-1516-OSC	<input type="radio"/>
	XX XX	1105-15XX-OSC	<input type="radio"/>
16" 40cm	16" 40cm	1105-1616-OSC	<input type="radio"/>
	18" 45cm	1105-1618-OSC	<input type="radio"/>
	20" 50cm	1105-1620-OSC	<input type="radio"/>
17" 43cm	XX XX	1105-16XX-OSC	<input type="radio"/>
	17" 43cm	1105-1717-OSC	<input type="radio"/>
	18" 45cm	1105-1718-OSC	<input type="radio"/>
18" 45cm	XX XX	1105-17XX-OSC	<input type="radio"/>
	18" 45cm	1105-1818-OSC	<input type="radio"/>
	20" 50cm	1105-1820-OSC	<input type="radio"/>
19" 48cm	22" 55cm	1105-1822-OSC	<input type="radio"/>
	XX XX	1105-18XX-OSC	<input type="radio"/>
	18" 45cm	1105-1918-OSC	<input type="radio"/>
20" 50cm	20" 50cm	1105-1920-OSC	<input type="radio"/>
	XX XX	1105-19XX-OSC	<input type="radio"/>
	18" 45cm	1105-2018-OSC	<input type="radio"/>
22" 55cm	20" 50cm	1105-2020-OSC	<input type="radio"/>
	22" 55cm	1105-2022-OSC	<input type="radio"/>
	XX XX	1105-20XX-OSC	<input type="radio"/>
24" 60cm	18" 45cm	1105-2218-OSC	<input type="radio"/>
	20" 50cm	1105-2220-OSC	<input type="radio"/>
	22" 55cm	1105-2222-OSC	<input type="radio"/>
Up to 20" 50cm	18" 45cm	1105-2418-OSC	<input type="radio"/>
Up to 25" 63cm	20" 50cm	1105-2420-OSC	<input type="radio"/>
	22" 55cm	1105-2422-OSC	<input type="radio"/>
	XX = _ _ _ _	1105-2929-OSC	<input type="radio"/>
	XX = _ _ _ _	1105-2939-OSC	<input type="radio"/>

PACKAGE INCLUDES:

1. Outer Cover
2. Incontinence Cover
3. Cushion Foam Unit
4. Strategic Positioning Base



TROUGH HEIGHT = 3CM

2. SELECT COLOUR

Your colour selection applies to any extra covers ordered

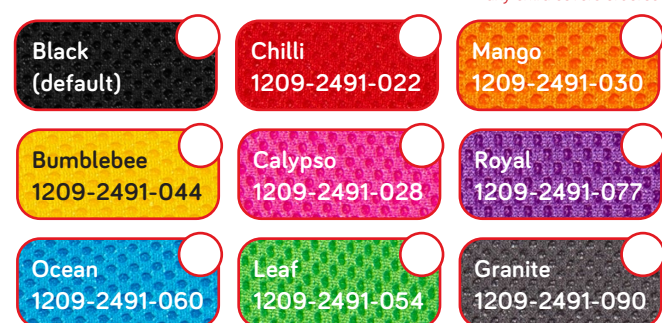

3. SELECT ACCESSORIES

✓	ACCESSORY	IMAGE
<input type="radio"/>	Extra Outer Cover (A) 1125-WWDD-6SC (insert width and depth relevant to cushion size)	
<input type="radio"/>	Extra Incontinence Cover (B) 1135-WWDD-7SC (insert width and depth relevant to cushion size)	
<input type="radio"/>	Rigidiser Base Panel 1110-WWDD-200 (can be inserted inside cover for a rigid surface)	
<input type="radio"/>	Extra Positioning Kit 1149-XXXX-062	
<input type="radio"/>	5° Wedge 1209-2724-300	

4. CUSTOMISE

Refer to Cushion Customisations (page 10).

Spex High Contour Cushion

1. SELECT SIZE

WIDTH	LENGTH	CODE	✓
8" 20cm	8" 20cm	1105-0808-0HC	<input type="radio"/>
	10" 25cm	1105-0810-0HC	<input type="radio"/>
10" 25cm	10" 25cm	1105-1010-0HC	<input type="radio"/>
	12" 30cm	1105-1012-0HC	<input type="radio"/>
	XX XX	1105-10XX-0HC	<input type="radio"/>
11" 28cm	10" 25cm	1105-1110-0HC	<input type="radio"/>
	12" 30cm	1105-1112-0HC	<input type="radio"/>
	XX XX	1105-11XX-0HC	<input type="radio"/>
12" 30cm	12" 30cm	1105-1212-0HC	<input type="radio"/>
	14" 35cm	1105-1214-0HC	<input type="radio"/>
	XX XX	1105-12XX-0HC	<input type="radio"/>
13" 33cm	12" 30cm	1105-1312-0HC	<input type="radio"/>
	14" 35cm	1105-1314-0HC	<input type="radio"/>
	XX XX	1105-13XX-0HC	<input type="radio"/>
14" 35cm	14" 35cm	1105-1414-0HC	<input type="radio"/>
	16" 40cm	1105-1416-0HC	<input type="radio"/>
	18" 45cm	1105-1418-0HC	<input type="radio"/>
	XX XX	1105-14XX-0HC	<input type="radio"/>
15" 38cm	14" 35cm	1105-1514-0HC	<input type="radio"/>
	16" 40cm	1105-1516-0HC	<input type="radio"/>
	XX XX	1105-15XX-0HC	<input type="radio"/>
16" 40cm	16" 40cm	1105-1616-0HC	<input type="radio"/>
	18" 45cm	1105-1618-0HC	<input type="radio"/>
	20" 50cm	1105-1620-0HC	<input type="radio"/>
17" 43cm	XX XX	1105-16XX-0HC	<input type="radio"/>
	17" 43cm	1105-1717-0HC	<input type="radio"/>
	18" 45cm	1105-1718-0HC	<input type="radio"/>
18" 45cm	XX XX	1105-17XX-0HC	<input type="radio"/>
	18" 45cm	1105-1818-0HC	<input type="radio"/>
	20" 50cm	1105-1820-0HC	<input type="radio"/>
19" 48cm	22" 55cm	1105-1822-0HC	<input type="radio"/>
	XX XX	1105-18XX-0HC	<input type="radio"/>
	18" 45cm	1105-1918-0HC	<input type="radio"/>
20" 50cm	20" 50cm	1105-1920-0HC	<input type="radio"/>
	XX XX	1105-19XX-0HC	<input type="radio"/>
	18" 45cm	1105-2018-0HC	<input type="radio"/>
22" 55cm	20" 50cm	1105-2020-0HC	<input type="radio"/>
	22" 55cm	1105-2022-0HC	<input type="radio"/>
	XX XX	1105-20XX-0HC	<input type="radio"/>
24" 60cm	18" 45cm	1105-2218-0HC	<input type="radio"/>
	20" 50cm	1105-2220-0HC	<input type="radio"/>
	22" 55cm	1105-2222-0HC	<input type="radio"/>
Up to 20" 50cm	18" 45cm	1105-2418-0HC	<input type="radio"/>
Up to 25" 63cm	20" 50cm	1105-2420-0HC	<input type="radio"/>
	22" 55cm	1105-2422-0HC	<input type="radio"/>
Up to 20" 50cm	XX = _ _ _ _	1105-2929-0HC	<input type="radio"/>
Up to 25" 63cm	XX = _ _ _ _	1105-2939-0HC	<input type="radio"/>

PACKAGE INCLUDES:

1. Outer Cover
2. Incontinence Cover
3. Cushion Foam Unit
4. Strategic Positioning Base



TROUGH HEIGHT = 5CM

2. SELECT COLOUR

Your colour selection applies to any extra covers ordered

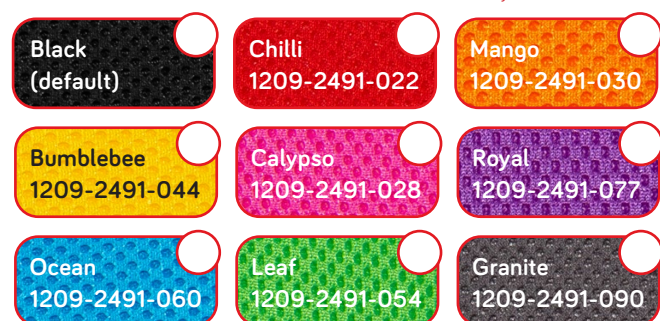

3. SELECT ACCESSORIES

✓	ACCESSORY	IMAGE
<input type="radio"/>	Extra Outer Cover (A) 1125-WWDD-6HC (insert width and depth relevant to cushion size)	
<input type="radio"/>	Extra Incontinence Cover (B) 1135-WWDD-7HC (insert width and depth relevant to cushion size)	
<input type="radio"/>	Rigidiser Base Panel 1110-WWDD-200 (can be inserted inside cover for a rigid surface)	
<input type="radio"/>	Extra Positioning Kit 1149-XXXX-060	
<input type="radio"/>	5° Wedge 1209-2724-300	

4. CUSTOMISE

Refer to Cushion Customisations (page 10).

Spex SuperHigh Contour Cushion

1. SELECT SIZE

WIDTH	LENGTH	CODE	✓
8" 20cm	8" 20cm	1105-0808-OSS	<input type="radio"/>
	10" 25cm	1105-0810-OSS	<input type="radio"/>
10" 25cm	10" 25cm	1105-1010-OSS	<input type="radio"/>
	12" 30cm	1105-1012-OSS	<input type="radio"/>
	XX XX	1105-10XX-OSS	<input type="radio"/>
11" 28cm	10" 25cm	1105-1110-OSS	<input type="radio"/>
	12" 30cm	1105-1112-OSS	<input type="radio"/>
	XX XX	1105-11XX-OSS	<input type="radio"/>
12" 30cm	12" 30cm	1105-1212-OSS	<input type="radio"/>
	14" 35cm	1105-1214-OSS	<input type="radio"/>
	XX XX	1105-12XX-OSS	<input type="radio"/>
13" 33cm	12" 30cm	1105-1312-OSS	<input type="radio"/>
	14" 35cm	1105-1314-OSS	<input type="radio"/>
	XX XX	1105-13XX-OSS	<input type="radio"/>
14" 35cm	14" 35cm	1105-1414-OSS	<input type="radio"/>
	16" 40cm	1105-1416-OSS	<input type="radio"/>
	18" 45cm	1105-1418-OSS	<input type="radio"/>
15" 38cm	XX XX	1105-14XX-OSS	<input type="radio"/>
	14" 35cm	1105-1514-OSS	<input type="radio"/>
	16" 40cm	1105-1516-OSS	<input type="radio"/>
16" 40cm	XX XX	1105-15XX-OSS	<input type="radio"/>
	16" 40cm	1105-1616-OSS	<input type="radio"/>
	18" 45cm	1105-1618-OSS	<input type="radio"/>
17" 43cm	20" 50cm	1105-1620-OSS	<input type="radio"/>
	XX XX	1105-16XX-OSS	<input type="radio"/>
	17" 43cm	1105-1717-OSS	<input type="radio"/>
18" 45cm	18" 45cm	1105-1718-OSS	<input type="radio"/>
	18" 45cm	1105-1818-OSS	<input type="radio"/>
	20" 50cm	1105-1820-OSS	<input type="radio"/>
19" 48cm	22" 55cm	1105-1822-OSS	<input type="radio"/>
	XX XX	1105-18XX-OSS	<input type="radio"/>
	18" 45cm	1105-1918-OSS	<input type="radio"/>
20" 50cm	20" 50cm	1105-1920-OSS	<input type="radio"/>
	20" 50cm	1105-2020-OSS	<input type="radio"/>
	22" 55cm	1105-2022-OSS	<input type="radio"/>
22" 55cm	XX XX	1105-20XX-OSS	<input type="radio"/>
	18" 45cm	1105-2218-OSS	<input type="radio"/>
	20" 50cm	1105-2220-OSS	<input type="radio"/>
24" 60cm	22" 55cm	1105-2222-OSS	<input type="radio"/>
	18" 45cm	1105-2418-OSS	<input type="radio"/>
	20" 50cm	1105-2420-OSS	<input type="radio"/>
Up to 20" 50cm	22" 55cm	1105-2422-OSS	<input type="radio"/>
Up to 25" 63cm	XX = _ _ _ _	1105-2929-OSS	<input type="radio"/>
	XX = _ _ _ _	1105-2939-OSS	<input type="radio"/>

PACKAGE INCLUDES:

1. Outer Cover
2. Incontinence Cover
3. Cushion Foam Unit
4. Strategic Positioning Base



10 - 13" TROUGH HEIGHT = 8CM
14"+ TROUGH HEIGHT = 10CM

2. SELECT COLOUR

Your colour selection applies to any extra covers ordered

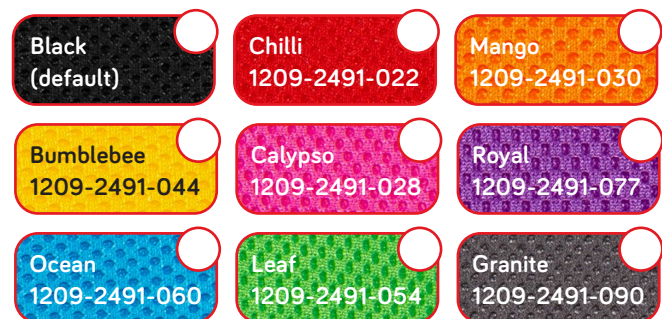

3. SELECT ACCESSORIES

✓	ACCESSORY	IMAGE
<input type="radio"/>	Extra Outer Cover (A) 1125-WWDD-6SS (insert width and depth relevant to cushion size)	
<input type="radio"/>	Extra Incontinence Cover (B) 1135-WWDD-7SS (insert width and depth relevant to cushion size)	
<input type="radio"/>	Rigidiser Base Panel 1110-WWDD-200 (can be inserted inside cover for a rigid surface)	
<input type="radio"/>	Extra Positioning Kit 1149-XXXX-063	
<input type="radio"/>	5° Wedge 1209-2724-300	

4. CUSTOMISE

Refer to Cushion Customisations (page 10).

Spex Constructa Cushion

PACKAGE INCLUDES:

- 1. Outer Cover
- 2. Overlay
- 3. Inner Cover
- 4. Base Foam
 - a. Contours
 - b. Ischial Insert
 - c. Positioning Blocks
 - d. Base
- 5. Adjustment Kit

1. SELECT CUSHION

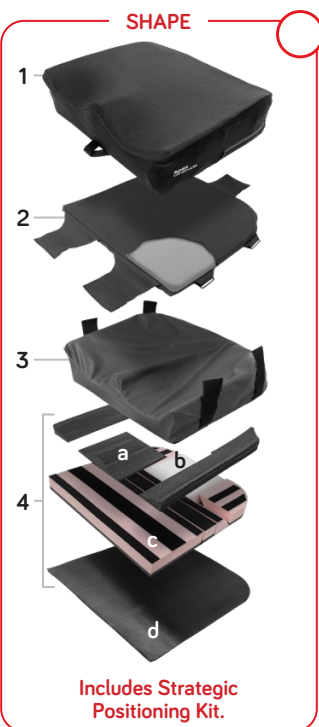

-1XXX

With Spare Outer Cover: -XCXX

Without Spare Outer Cover: -X0XX

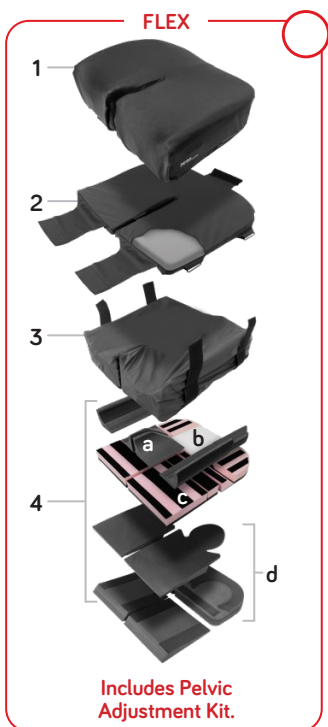

-FXXX

2. SELECT CONTOURING

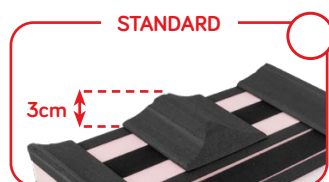

-XXSC



-XXHC



-XXSS

3. SELECT SIZE

WIDTH	LENGTH	CODE	✓
14" 35cm	14" 35cm	1102-1414-XXXX	<input type="radio"/>
	16" 40cm	1102-1416-XXXX	<input type="radio"/>
	18" 45cm	1102-1418-XXXX	<input type="radio"/>
16" 40cm	16" 40cm	1102-1616-XXXX	<input type="radio"/>
	18" 45cm	1102-1618-XXXX	<input type="radio"/>
	20" 50cm	1102-1620-XXXX	<input type="radio"/>
18" 45cm	18" 45cm	1102-1818-XXXX	<input type="radio"/>
	20" 50cm	1102-1820-XXXX	<input type="radio"/>
20" 50cm	20" 50cm	1102-2020-XXXX	<input type="radio"/>
	22" 55cm	1102-2022-XXXX	<input type="radio"/>

4. SELECT ACCESSORIES

✓	ACCESSORY	IMAGE
<input checked="" type="checkbox"/>	Extra Outer Cover, Standard or High Contour <input type="radio"/> Shape: 1102-WWDD-OOC-C <input type="radio"/> Flex: 1102-WWDD-FOC-C (insert width relevant to cushion size)	
<input type="checkbox"/>	Extra Outer Cover, Superhigh Contour <input type="radio"/> Shape: 1102-WWDD-OSS-C <input type="radio"/> Flex: 1102-WWDD-FSS-C (insert width relevant to cushion size)	
<input type="checkbox"/>	Flexy Contour 1102-WW00-00F (insert width relevant to cushion size)	
<input type="checkbox"/>	Constructa Flex Extra Pelvic Adjustment Kit 1102-WW00-F00 (insert width relevant to cushion size)	
<input type="checkbox"/>	Constructa Shape Extra Strategic Positioning Kit 1102-WW00-000 (insert width relevant to cushion size)	
<input type="checkbox"/>	Rigidiser Base Panel (can be inserted inside cover for a rigid surface) 1110-WWDD-200	
<input type="checkbox"/>	5° Wedge 1209-2724-300	
<input type="checkbox"/>	Extra 7.5 Degree Wedge (Flex 1 leg only) 1102-WWDD-321	

5. CUSTOMISE

Customise your Constructa Cushion with extra components available from our **Constructa Cushion Spare Parts Script**.

XLella Cushion

PACKAGE INCLUDES:

1. Outer Cover
2. Incontinence Cover
3. Cushion Foam Unit
4. Strategic Positioning Base (Spex Classic Cushions only)



1. SELECT XLELLA CUSHION STYLE

Vigour
Standard Contour



1103-WWDD-0SC

Spex Classic
Standard Contour



1105-WWDD-0SC

Spex Classic
High Contour



1105-WWDD-0HC

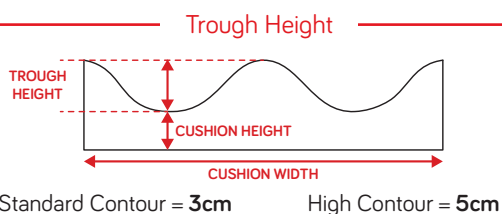

2. SELECT SIZING

To order replace WW and DD in code

Cushion Depth (DD) (inches)	Cushion Width (WW) (inches)					
	20	22	24	26	28	30
18						
19						
20						
21						
22						
23						
24						
25						
26						

XLella Cushion Size Available

XLella Cushion Size Made To Order - Cushion Depth can be specified to suit

3. SELECT COLOUR

Your colour selection applies to any extra covers ordered

Black
(default)

Chilli
1209-2491-022

Mango
1209-2491-030

Bumblebee
1209-2491-044

Calypso
1209-2491-028

Royal
1209-2491-077

Ocean
1209-2491-060

Leaf
1209-2491-054

Granite
1209-2491-090

4. SELECT ACCESSORIES

✓ ACCESSORY

Extra Outer Cover (A)

- Vigour Std: 1123-WWDD-6SC
- Classic Std: 1125-WWDD-6SC
- Classic High: 1125-WWDD-6HC (insert width & depth as relevant)

Extra Incontinence Cover (B)

- Vigour Std: 1133-WWDD-7SC
- Classic Std: 1135-WWDD-7SC
- Classic High: 1135-WWDD-7HC (insert width & depth as relevant)

Extra Positioning Kit

- (Spex Classic Cushions only)
1149-XXXX-062

IMAGE

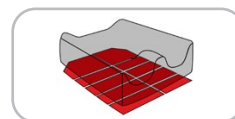
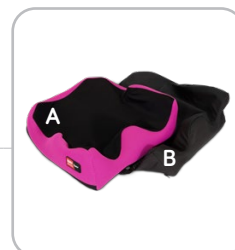

5. CUSTOMISE

✓ CUSTOMISATION

Remove Medial Thigh Contouring

- 1119-0282-000
- Achieve flat front surface without any contouring. Ideal relief for excess tissue and to facilitate easy transfers.

Front Surface Cut-Back

- M = _____
- 1119-0290-000
- Sloping front for users with excess tissue or to provide relief when transferring and/or foot propelling.

IMAGE

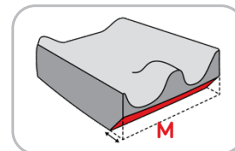
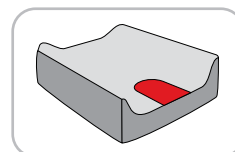

Cushion Customisations

<input type="radio"/> Medial Thigh Support - Specified measurements 1119-0281-000	Measurements (cm) E _____ F _____ G _____ H _____			Reference
	<input type="radio"/> Medial Thigh Support - Pre-set options 1119-XXXX-000	Pre-set (cm) Standard <input type="radio"/> -0283- High <input type="radio"/> -0284- SuperHigh <input type="radio"/> -0285-		

Leg Length Discrepancy 1119-0293-000	Users Left (cm) L _____	Users Right (cm) L _____	Reference
--	----------------------------	-----------------------------	----------------------

Contacture Undercut - Front of Cushion 1119-0290-000	Users Left (cm) M _____	Users Right (cm) M _____	Reference
--	----------------------------	-----------------------------	----------------------

<input type="radio"/> Hip Belt Cut Out 1119-0294-000	<input type="radio"/> Users Left (cm) N _____ O _____	<input type="radio"/> Users Right (cm) N _____ O _____	Reference
--	---	--	----------------------

<input type="radio"/> Angled Shelf Cushion Base 45° shelf starts where ischial well stops. 1119-0261-000	Measurements (cm) R _____	Reference
---	------------------------------	----------------------

1/2" Gel Foam Overlay
(N/A for cushions 22" x 22" and greater).

The soft upper layer will be replaced with this overlay.
Max Size = 22" x 32"
1119-0391-000

1/2" Soft Pressure Relieving Foam Overlay

1/2" Soft Pressure Relieving Foam.
Max Size = 32" x 32"
1119-0390-000

1" Soft Gel Foam Ischial Well Insert

1119-0351-000

Universal Positioning Base

1. SELECT BASE

CUSHION SPACER KIT



ISCHIAL CONTOUR CUSHION SPACER KIT



HIP FLEXION CONTOUR SPACER KIT

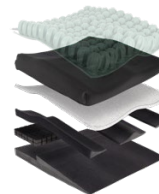

PACKAGE INCLUDES:

10mm spacer, 20mm spacer
8 x obliquity spacer squares
Raises cushion for extra long leg lengths,
or as a base for attaching contouring
support wedges.

10mm spacer base
25mm front ischial ledge
8 x obliquity spacer squares
Helps to prevent posterior pelvic sliding.

Base with 25mm high ischial ledge
8 x obliquity spacer squares
Helps to prevent posterior pelvic sliding.
Allows for 10° Hip Flexion relief.

2. SELECT SIZE

	WIDTH	LENGTH	CODE	✓
Cushion spacer kit	14" 35cm	14" 35cm	1113-01-1414	<input type="radio"/>
		16" 40cm	1113-01-1416	<input type="radio"/>
		18" 45cm	1113-01-1418	<input type="radio"/>
	16" 40cm	16" 40cm	1113-01-1616	<input type="radio"/>
		18" 45cm	1113-01-1618	<input type="radio"/>
		20" 50cm	1113-01-1620	<input type="radio"/>
	18" 45cm	18" 45cm	1113-01-1818	<input type="radio"/>
		20" 50cm	1113-01-1820	<input type="radio"/>
		20" 50cm	18" 45cm	1113-01-2018
20" 50cm	1113-01-2020		<input type="radio"/>	
Ischial contour cushion Spacer kit	14" 35cm	14" 35cm	1113-02-1414	<input type="radio"/>
		16" 40cm	1113-02-1416	<input type="radio"/>
		18" 45cm	1113-02-1418	<input type="radio"/>
	16" 40cm	16" 40cm	1113-02-1616	<input type="radio"/>
		18" 45cm	1113-02-1618	<input type="radio"/>
		20" 50cm	1113-02-1620	<input type="radio"/>
	18" 45cm	18" 45cm	1113-02-1818	<input type="radio"/>
		20" 50cm	1113-02-1820	<input type="radio"/>
		20" 50cm	18" 45cm	1113-02-2018
20" 50cm	1113-02-2020		<input type="radio"/>	
Hip flexion contour Spacer kit	14" 35cm	14" 35cm	1113-03-1414	<input type="radio"/>
		16" 40cm	1113-03-1416	<input type="radio"/>
		18" 45cm	1113-03-1418	<input type="radio"/>
	16" 40cm	16" 40cm	1113-03-1616	<input type="radio"/>
		18" 45cm	1113-03-1618	<input type="radio"/>
		20" 50cm	1113-03-1620	<input type="radio"/>
	18" 45cm	18" 45cm	1113-03-1818	<input type="radio"/>
		20" 50cm	1113-03-1820	<input type="radio"/>
		20" 50cm	18" 45cm	1113-03-2018
20" 50cm	1113-03-2020		<input type="radio"/>	

3. SELECT CONTOUR KIT

LENGTH	CODE	✓
14" 35cm	1113-05-0014	<input type="radio"/>
16" 40cm	1113-05-0016	<input type="radio"/>
18" 45cm	1113-05-0018	<input type="radio"/>
20" 50cm	1113-05-0020	<input type="radio"/>
XX = ----	1113-05-0029	<input type="radio"/>



4. SELECT COVER COMBINATION

WIDTH	LENGTH	CODE	✓
14" 35cm	14" 35cm	1113-07-1414	<input type="radio"/>
	16" 40cm	1113-07-1416	<input type="radio"/>
	18" 45cm	1113-07-1418	<input type="radio"/>
16" 40cm	16" 40cm	1113-07-1616	<input type="radio"/>
	18" 45cm	1113-07-1618	<input type="radio"/>
	20" 50cm	1113-07-1620	<input type="radio"/>
18" 45cm	18" 45cm	1113-07-1818	<input type="radio"/>
	20" 50cm	1113-07-1820	<input type="radio"/>
20" 50cm	18" 45cm	1113-07-2018	<input type="radio"/>
	20" 50cm	1113-07-2020	<input type="radio"/>
XX = ----	XX = ----	1113-07-2929	<input type="radio"/>



Zygo Back Support

PACKAGE INCLUDES:

- 1. Aluminium Shell
- 2. Foam System
- 3. Outer Cover
- 4. Foam Wedges
- 5. Cover Extension
(Note: hardware must be selected)

1. SELECT ZYGO CONTOUR OPTION



Active Lo
1251-WWHH-OAL



Active Mid
1251-WWHH-OAM



Deep Lo
1251-WWHH-ODL



Deep Mid
1251-WWHH-ODM

2. SELECT SIZING

To order replace
WW and HH in code

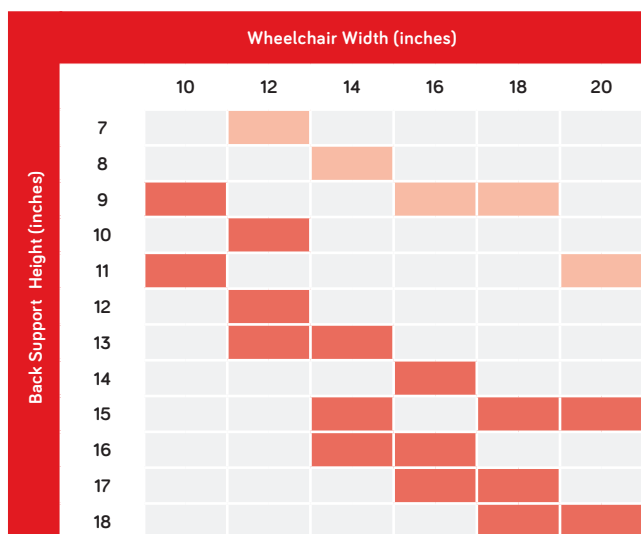

Lo Back Support Mid Back Support

3. SELECT HARDWARE - DROP MOUNT

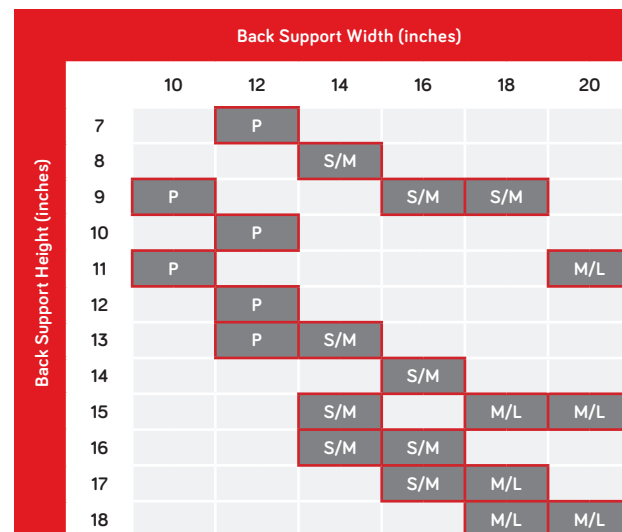

Paediatric
1259-1400-00P



Small
1259-1400-00S



Medium
1259-1400-00M



Large
1259-1400-00L

4. ADD ACCESSORIES



TSS Lite contouring & positioning kit
1250-3955-000



Harness Guides
1400-6692-000

5. BUILD CODE

REFER TO THE ZYGO BACK SUPPORT CODES ABOVE

1 2 5 1 - - - - - 0 - - -

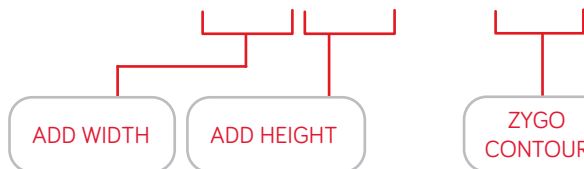

Vigour Back Support

PACKAGE INCLUDES:

1. Aluminium Shell
 2. Foam System
 3. Outer Cover
 4. Posterior Pelvic Support & Positioning Wedges
- (Note: hardware must be selected)



1. SELECT SIZE

WIDTH	LENGTH	CODE	✓
10" 25cm	12" 30cm	1252-1012-00H	<input type="radio"/>
	14" 35cm	1252-1014-00H	<input type="radio"/>
	16" 40cm	1252-1016-00H	<input type="radio"/>
11" 28cm	12" 30cm	1252-1112-00H	<input type="radio"/>
	14" 35cm	1252-1114-00H	<input type="radio"/>
	16" 40cm	1252-1116-00H	<input type="radio"/>
12" 30cm	14" 35cm	1252-1214-00H	<input type="radio"/>
	16" 40cm	1252-1216-00H	<input type="radio"/>
	18" 45cm	1252-1218-00H	<input type="radio"/>
13" 33cm	14" 35cm	1252-1314-00H	<input type="radio"/>
	16" 40cm	1252-1316-00H	<input type="radio"/>
	18" 45cm	1252-1318-00H	<input type="radio"/>
14" 35cm	16" 40cm	1252-1416-00H	<input type="radio"/>
	18" 45cm	1252-1418-00H	<input type="radio"/>
	20" 50cm	1252-1420-00H	<input type="radio"/>
15" 38cm	16" 40cm	1252-1516-00H	<input type="radio"/>
	18" 45cm	1252-1518-00H	<input type="radio"/>
	20" 50cm	1252-1520-00H	<input type="radio"/>
16" 40cm	18" 45cm	1252-1618-00H	<input type="radio"/>
	20" 50cm	1252-1620-00H	<input type="radio"/>
	23" 58cm	1252-1623-00H	<input type="radio"/>
17" 43cm	18" 45cm	1252-1718-00H	<input type="radio"/>
	20" 50cm	1252-1720-00H	<input type="radio"/>
	23" 58cm	1252-1723-00H	<input type="radio"/>
18" 45cm	18" 45cm	1252-1818-00H	<input type="radio"/>
	20" 50cm	1252-1820-00H	<input type="radio"/>
	23" 58cm	1252-1823-00H	<input type="radio"/>
19" 48cm	18" 45cm	1252-1918-00H	<input type="radio"/>
	20" 50cm	1252-1920-00H	<input type="radio"/>
	23" 58cm	1252-1923-00H	<input type="radio"/>
20" 50cm	18" 45cm	1252-2018-00H	<input type="radio"/>
	20" 50cm	1252-2020-00H	<input type="radio"/>
	23" 58cm	1252-2023-00H	<input type="radio"/>

2. SELECT COLOUR

Your colour selection applies to any extra covers ordered

Black (default)	Chilli 1209-2491-022	Mango 1209-2491-030
Bumblebee 1209-2491-044	Calypso 1209-2491-028	Royal 1209-2491-077
Ocean 1209-2491-060	Leaf 1209-2491-054	Granite 1209-2491-090

3. SELECT HARDWARE

Single Mount 1259-2100-100	Dual Mount 1259-2200-100	Quad Mount 1259-2400-100	Quad Mount, Heavy Duty, up to 23" wide 1259-2405-100
Quad Mount, Heavy Duty, 23" wide + 1259-2406-100	Direct Mount 1259-2460-100	Drop Mount Paediatric: 1259-1400-00P Small: 1259-1400-00S Medium: 1259-1400-00M Large: 1259-1400-00L	Quad Extension Brackets 1259-2450-100

4. ADD ACCESSORIES

Additional backrest lumber pad and lateral stability wedges 1209-2713-300	Asymmetric narrow contour wedge (200mm x 100mm x 40mm) 1209-2722-300	Asymmetric bi-angular contour wedge (200mm x 100mm x 40mm) 1209-2723-300
Asymmetric contour kit 1209-2720-300	Extra Outer Cover (A) Extra Incontinence Cover (B) 1209-2713-300	T-shape modification 1209-2931-000 Surface / I Shape modification 1209-2936-000

Growth-Adjust Back Support

GROWTH-ADJUST

SPEX CLASSIC GROWTH-ADJUST

SPEX CLASSIC T SHAPE GROWTH-ADJUST



PACKAGE INCLUDES:

1. Growth-Adjust Aluminium Shell
2. Foam System
3. Outer Cover
4. Growth Kit of foam parts
5. Posterior Pelvic Support & Positioning Wedges

(Note: hardware must be selected)



1. SELECT SIZE

GROWTH-ADJUST

WIDTH	LENGTH	CODE	✓
12" 30cm	11"-15" 28-38cm	1252-1211-OGA	<input type="radio"/>
	14"-18" 35-45cm	1252-1214-OGA	<input type="radio"/>
14" 35cm	12"-17" 30-43cm	1252-1412-OGA	<input type="radio"/>
	16"-21" 40-53cm	1252-1416-OGA	<input type="radio"/>
16" 40cm	14"-20" 35-50cm	1252-1614-OGA	<input type="radio"/>
	18"-24" 45-60cm	1252-1618-OGA	<input type="radio"/>

SPEX CLASSIC GROWTH-ADJUST

WIDTH	LENGTH	CODE	✓
12" 30cm	11"-15" 28-38cm	1255-1211-OGA	<input type="radio"/>
	14"-18" 35-45cm	1255-1214-OGA	<input type="radio"/>
14" 35cm	12"-17" 30-43cm	1255-1412-OGA	<input type="radio"/>
	16"-21" 40-53cm	1255-1416-OGA	<input type="radio"/>
16" 40cm	14"-20" 35-50cm	1255-1614-OGA	<input type="radio"/>
	18"-24" 45-60cm	1255-1618-OGA	<input type="radio"/>

SPEX CLASSIC T SHAPE GROWTH-ADJUST

WIDTH	LENGTH	CODE	✓
12" 30cm	11"-15" 28-38cm	1255-1211-TGA	<input type="radio"/>
	14"-18" 35-45cm	1255-1214-TGA	<input type="radio"/>
14" 35cm	12"-17" 30-43cm	1255-1412-TGA	<input type="radio"/>
	16"-21" 40-53cm	1255-1416-TGA	<input type="radio"/>
16" 40cm	14"-20" 35-50cm	1255-1614-TGA	<input type="radio"/>
	18"-24" 45-60cm	1255-1618-TGA	<input type="radio"/>

2. SELECT COLOUR

Your colour selection applies to any extra covers ordered

Black (default)	Chilli 1209-2491-022	Mango 1209-2491-030
Bumblebee 1209-2491-044	Calypso 1209-2491-028	Royal 1209-2491-077
Ocean 1209-2491-060	Leaf 1209-2491-054	Granite 1209-2491-090

3. SELECT HARDWARE

Single Mount 1259-2100-100	Dual Mount 1259-2200-100	Quad Mount 1259-2400-100	Drop Mount
			<input type="radio"/> Paediatric: 1259-1400-00P <input type="radio"/> Small: 1259-1400-00S <input type="radio"/> Medium: 1259-1400-00M <input type="radio"/> Large: 1259-1400-00L

4. ADD ACCESSORIES

Spare Growth Kit, Growth Adjust -	Spare Growth Kit, Spex Classic -	Centrepoint Harness -
<input type="radio"/> 12" Width: 1252-1200-CGA <input type="radio"/> 14" Width: 1252-1400-CGA <input type="radio"/> 16" Width: 1252-1600-CGA	<input type="radio"/> 12" Width: 1255-1200-CGA <input type="radio"/> 14" Width: 255-1400-CGA <input type="radio"/> 16" Width: 1255-1200-CGA	<input type="radio"/> 12" Width: 1409-5660-017 <input type="radio"/> 14" Width: 1409-5661-017 <input type="radio"/> 16" Width, Small: 1409-6661-017 <input type="radio"/> 16" Width, Medium: 1409-6662-017
Harness Guides (16" Width only) 1400-6692-000	Lite Head Support Hardware -	Quick-Release Head Support Hardware -
	<input type="radio"/> 12" Width: 1274-0232-100 <input type="radio"/> 14" Width: 1274-0232-100	<input type="radio"/> 12" Width: 1274-3232-100 <input type="radio"/> 14" Width: 1274-3232-100
Stylo 130 Mechanism 1274-1232-000	Stylo 160 Fixed Standard Mechanism (16" Width only) 1274-1252-000	Stylo 260 Fixed Standard Mechanism (16" Width only) 1274-1282-000
Extra Covers	Stylo 160 Flipback Standard Mechanism (16" Width only)	Stylo 260 Flipback Standard Mechanism (16" Width only)
Outer (A): 1252-1200-CGA Incontinence (B): 1252-1400-CGA	1274-2252-000	1274-2282-000

Manta Back Support

PACKAGE INCLUDES:

1. Aluminium Shell
2. Foam System
3. Outer Cover
4. Posterior Pelvic Support & Positioning Wedges

(Note: hardware must be selected)



3. SELECT HARDWARE

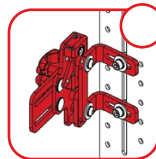

Single Mount
1259-2100-100

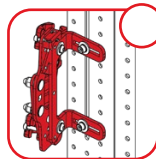

Dual Mount
1259-2200-100



Quad Mount
1259-2400-100

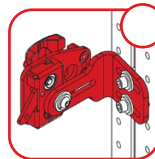

Quad Mount, Heavy Duty, up to 23" wide
1259-2405-100



Quad Mount, Heavy Duty, 23" wide +
1259-2406-100

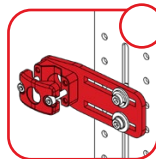

Direct Mount
1259-2460-100

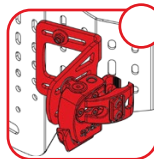

Drop Mount
 Paediatric: 1259-1400-00P
 Small: 1259-1400-00S
 Medium: 1259-1400-00M
 Large: 1259-1400-00L

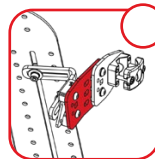

Quad Extension Brackets
1259-2450-100

1. SELECT SIZE

WIDTH	LENGTH	CODE	✓
12" 30cm	14" 35cm	1254-1214-000	<input type="radio"/>
	16" 40cm	1254-1216-000	<input type="radio"/>
13" 33cm	14" 35cm	1254-1314-000	<input type="radio"/>
	16" 40cm	1254-1316-000	<input type="radio"/>
14" 35cm	16" 40cm	1254-1416-000	<input type="radio"/>
	18" 45cm	1254-1418-000	<input type="radio"/>
15" 38cm	16" 40cm	1254-1516-000	<input type="radio"/>
	18" 45cm	1254-1518-000	<input type="radio"/>
16" 40cm	18" 45cm	1254-1618-000	<input type="radio"/>
	20" 50cm	1254-1620-000	<input type="radio"/>
17" 43cm	18" 45cm	1254-1718-000	<input type="radio"/>
	20" 50cm	1254-1720-000	<input type="radio"/>
18" 45cm	18" 45cm	1254-1818-000	<input type="radio"/>
	20" 50cm	1254-1820-000	<input type="radio"/>
19" 48cm	18" 45cm	1254-1918-000	<input type="radio"/>
	20" 50cm	1254-1920-000	<input type="radio"/>
20" 50cm	18" 45cm	1254-2018-000	<input type="radio"/>
	20" 50cm	1254-2020-000	<input type="radio"/>

2. SELECT COLOUR

Your colour selection applies to any extra covers ordered

Black (default) 1209-2491-000	Chilli 1209-2491-022	Mango 1209-2491-030
Bumblebee 1209-2491-044	Calypso 1209-2491-028	Royal 1209-2491-077
Ocean 1209-2491-060	Leaf 1209-2491-054	Granite 1209-2491-090

4. ADD ACCESSORIES

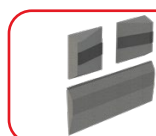

Additional backrest lumber pad and lateral stability wedges
1209-2713-300



Asymmetric narrow contour wedge (200mm x 100mm x 40mm)
1209-2722-300



Asymmetric bi-angular contour wedge (200mm x 100mm x 40mm)
1209-2723-300

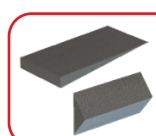

Asymmetric contour kit
1209-2720-300



**Extra Outer Cover (A)
Extra Incontinence Cover (B)**

Adapta Back Support

1. SELECT BACK SUPPORT



Adapta²
1257-WWHH-200



Adapta³
1257-WWHH-300

2. SELECT FOAM LENGTH - ADAPTA³ ONLY

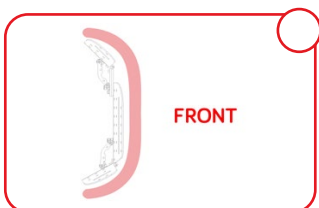

Standard
1257-WWHH-300

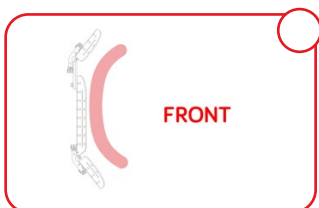

Kyphotic
1257-WWHH-30K

5. SELECT HARDWARE - FOR ADAPTA

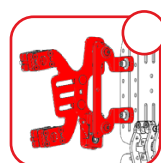

Forward Dual Mount (Default for Adapta²)
1259-2210-100

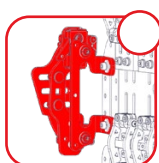

Dual Mount (Default for Adapta³)
1259-2205-100

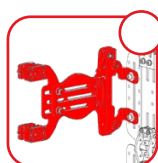

Forward Extended Dual Mount
1259-2215-100

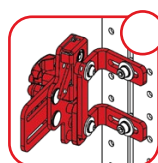

Single Mount
1259-2100-100

6. SELECT UPGRADES & ACCESSORIES

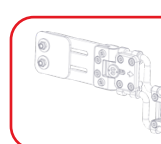

Depth Reduced Axial Swing-Away Lateral Support
1266-2331-100



TSS Lite Contouring Kit
1250-3955-000

Adapta Shoulder Harness Guide Hardware
1400-6693-000

15mm Thick Low Resilient Foam to Front of Backrest
1209-2348-300

3. SELECT SIZING

To order replace **WW** and **HH** in code

		Wheelchair Width (inches)					
		12	14	16	18	20	22
Back Support Height (inches)	12						
	13						
	14						
	15						
	16						
	17		+2"				
	18						
	19		+2"	+2"			
	20						
	21			+2"	+2"	+2"	
	22						
23				+2"	+2"		

Adapta² Back Support Adapta³ Back Support

ADAPTA³ HAS 2" OF HEIGHT GROWTH

SELECT UPGRADES - FOR ADAPTA³ ONLY

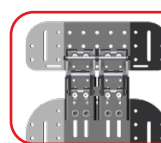

Flipback Upgrade for Top Section
1257-WWHH-XFX



Reduced Length Stem - Stylo 160 (mandatory for head support use)
1274-1255-000



Reduced Length Stem - Stylo 260 (mandatory for head support use)
1274-1285-000

7. BUILD CODE

REFER TO THE ADAPTA BACK SUPPORT CODES ABOVE

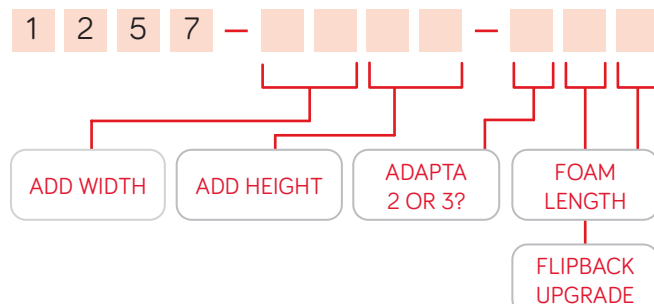

4. SELECT COLOUR

Your colour selection applies to any extra covers ordered

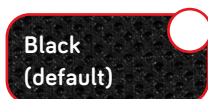

Black
(default)

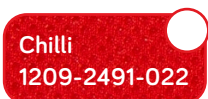

Chilli
1209-2491-022



Mango
1209-2491-030



Bumblebee
1209-2491-044

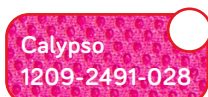

Calypso
1209-2491-028

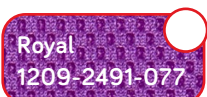

Royal
1209-2491-077



Ocean
1209-2491-060

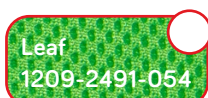

Leaf
1209-2491-054

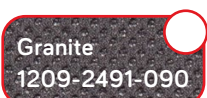

Granite
1209-2491-090

Comfi Back Support

PACKAGE INCLUDES:

1. Aluminium Shell
2. Foam System
3. Outer Cover
4. Posterior Pelvic Support & Positioning Wedges

(Note: hardware must be selected)



1. SELECT SIZE

WIDTH	LENGTH	CODE	✓
10" 25cm	12" 30cm	1253-1012-00H	<input type="radio"/>
	14" 35cm	1253-1014-00H	<input type="radio"/>
	16" 40cm	1253-1016-00H	<input type="radio"/>
11" 28cm	12" 30cm	1253-1112-00H	<input type="radio"/>
	14" 35cm	1253-1114-00H	<input type="radio"/>
	16" 40cm	1253-1116-00H	<input type="radio"/>
12" 30cm	14" 35cm	1253-1214-00H	<input type="radio"/>
	16" 40cm	1253-1216-00H	<input type="radio"/>
	18" 45cm	1253-1218-00H	<input type="radio"/>
13" 33cm	14" 35cm	1253-1314-00H	<input type="radio"/>
	16" 40cm	1253-1316-00H	<input type="radio"/>
	18" 45cm	1253-1318-00H	<input type="radio"/>
14" 35cm	16" 40cm	1253-1416-00H	<input type="radio"/>
	18" 45cm	1253-1418-00H	<input type="radio"/>
	20" 50cm	1253-1420-00H	<input type="radio"/>
15" 38cm	16" 40cm	1253-1516-00H	<input type="radio"/>
	18" 45cm	1253-1518-00H	<input type="radio"/>
	20" 50cm	1253-1520-00H	<input type="radio"/>
16" 40cm	18" 45cm	1253-1618-00H	<input type="radio"/>
	20" 50cm	1253-1620-00H	<input type="radio"/>
	23" 58cm	1253-1623-00H	<input type="radio"/>
17" 43cm	18" 45cm	1253-1718-00H	<input type="radio"/>
	20" 50cm	1253-1720-00H	<input type="radio"/>
	23" 58cm	1253-1723-00H	<input type="radio"/>
18" 45cm	18" 45cm	1253-1818-00H	<input type="radio"/>
	20" 50cm	1253-1820-00H	<input type="radio"/>
	23" 58cm	1253-1823-00H	<input type="radio"/>
19" 48cm	18" 45cm	1253-1918-00H	<input type="radio"/>
	20" 50cm	1253-1920-00H	<input type="radio"/>
	23" 58cm	1253-1923-00H	<input type="radio"/>
20" 50cm	18" 45cm	1253-2018-00H	<input type="radio"/>
	20" 50cm	1253-2020-00H	<input type="radio"/>
	23" 58cm	1253-2023-00H	<input type="radio"/>

2. SELECT COLOUR

Your colour selection applies to any extra covers ordered

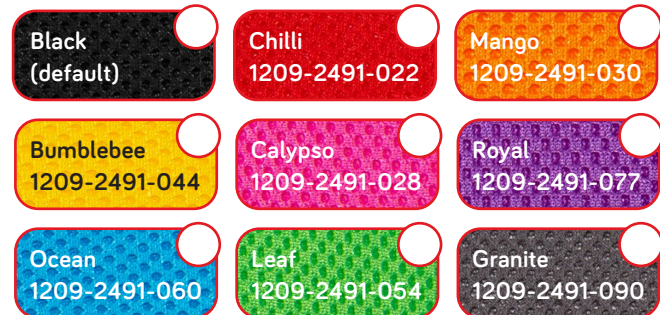

3. SELECT HARDWARE

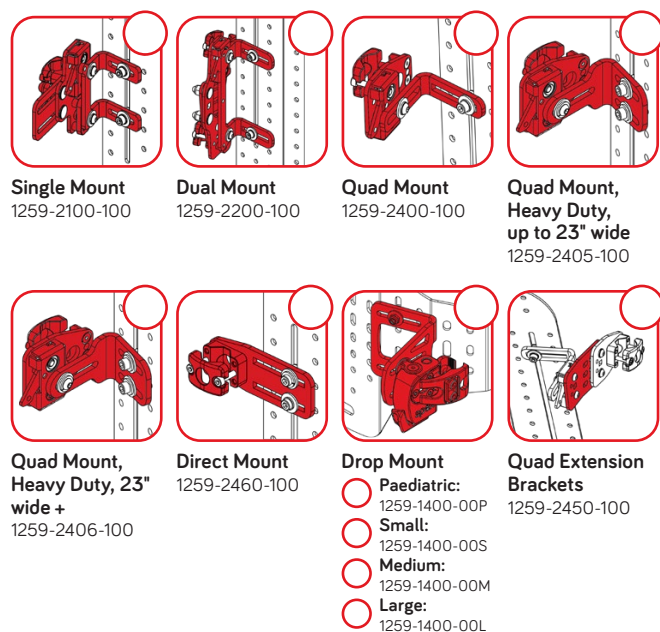

4. ADD ACCESSORIES

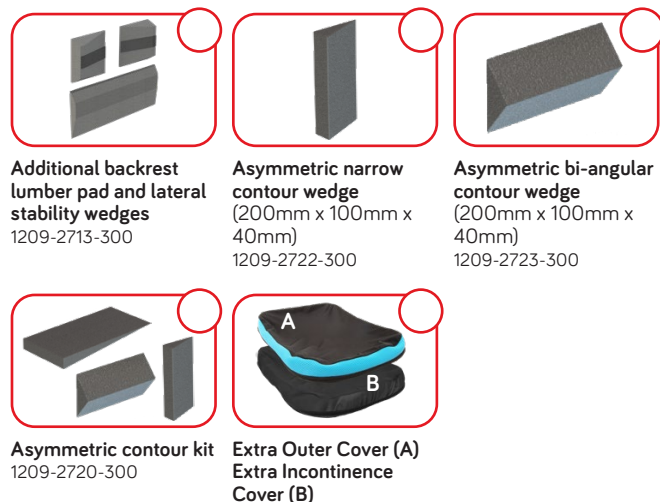

Spex Classic Back Support

PACKAGE INCLUDES:

1. Aluminium Shell
2. Foam System
3. Outer Cover
4. Spare Pack of foam cubes
5. Posterior Pelvic Support & Positioning Wedges

(Note: hardware must be selected)



2. SELECT COLOUR

Your colour selection applies to any extra covers ordered

Black (default) 1209-2491-022	Chilli 1209-2491-022	Mango 1209-2491-030
Bumblebee 1209-2491-044	Calypso 1209-2491-028	Royal 1209-2491-077
Ocean 1209-2491-060	Leaf 1209-2491-054	Granite 1209-2491-090

1. SELECT SIZE

WIDTH	LENGTH	CODE	✓
10" 25cm	12" 30cm	1255-1012-OSS	<input type="radio"/>
	14" 35cm	1255-1014-OSS	<input type="radio"/>
	16" 40cm	1255-1016-OSS	<input type="radio"/>
11" 28cm	12" 30cm	1255-1112-OSS	<input type="radio"/>
	14" 35cm	1255-1114-OSS	<input type="radio"/>
	16" 40cm	1255-1116-OSS	<input type="radio"/>
12" 30cm	14" 35cm	1255-1214-OSS	<input type="radio"/>
	16" 40cm	1255-1216-OSS	<input type="radio"/>
	18" 45cm	1255-1218-OSS	<input type="radio"/>
13" 33cm	14" 35cm	1255-1314-OSS	<input type="radio"/>
	16" 40cm	1255-1316-OSS	<input type="radio"/>
	18" 45cm	1255-1318-OSS	<input type="radio"/>
14" 35cm	16" 40cm	1255-1416-OSS	<input type="radio"/>
	18" 45cm	1255-1418-OSS	<input type="radio"/>
	20" 50cm	1255-1420-OSS	<input type="radio"/>
15" 38cm	16" 40cm	1255-1516-OSS	<input type="radio"/>
	18" 45cm	1255-1518-OSS	<input type="radio"/>
	20" 50cm	1255-1520-OSS	<input type="radio"/>
16" 40cm	18" 45cm	1255-1618-OSS	<input type="radio"/>
	20" 50cm	1255-1620-OSS	<input type="radio"/>
	23" 58cm	1255-1623-OSS	<input type="radio"/>
17" 43cm	18" 45cm	1255-1718-OSS	<input type="radio"/>
	20" 50cm	1255-1720-OSS	<input type="radio"/>
	23" 58cm	1255-1723-OSS	<input type="radio"/>
18" 45cm	18" 45cm	1255-1818-OSS	<input type="radio"/>
	20" 50cm	1255-1820-OSS	<input type="radio"/>
	23" 58cm	1255-1823-OSS	<input type="radio"/>
19" 48cm	18" 45cm	1255-1918-OSS	<input type="radio"/>
	20" 50cm	1255-1920-OSS	<input type="radio"/>
	23" 58cm	1255-1923-OSS	<input type="radio"/>
20" 50cm	18" 45cm	1255-2018-OSS	<input type="radio"/>
	20" 50cm	1255-2020-OSS	<input type="radio"/>
	23" 58cm	1255-2023-OSS	<input type="radio"/>

3. SELECT HARDWARE

Single Mount 1259-2100-100	Dual Mount 1259-2200-100	Quad Mount 1259-2400-100	Quad Mount, Heavy Duty, up to 23" wide 1259-2405-100
Quad Mount, Heavy Duty, 23" wide + 1259-2406-100	Direct Mount 1259-2460-100	Drop Mount <input type="radio"/> Paediatric: 1259-1400-00P <input type="radio"/> Small: 1259-1400-00S <input type="radio"/> Medium: 1259-1400-00M <input type="radio"/> Large: 1259-1400-00L	Quad Extension Brackets 1259-2450-100

4. ADD ACCESSORIES

Additional backrest lumber pad and lateral stability wedges 1209-2713-300	Asymmetric narrow contour wedge (200mm x 100mm x 40mm) 1209-2722-300	Asymmetric bi-angular contour wedge (200mm x 100mm x 40mm) 1209-2723-300
Asymmetric contour kit 1209-2720-300	Extra Outer Cover (A) Extra Incontinence Cover (B)	Extra Positioning Kit (pack 10 cubes) 1255-XXXX-300

Spex T-Shape Back Support

PACKAGE INCLUDES:

1. T-Shape Aluminium Shell
2. Foam System
3. Outer Cover
4. Spare Pack of foam cubes
5. Posterior Pelvic Support & Positioning Wedges

(Note: hardware must be selected)



2. SELECT COLOUR

Your colour selection applies to any extra covers ordered

Black (default) 1209-2491-022	Chilli 1209-2491-022	Mango 1209-2491-030
Bumblebee 1209-2491-044	Calypso 1209-2491-028	Royal 1209-2491-077
Ocean 1209-2491-060	Leaf 1209-2491-054	Granite 1209-2491-090

1. SELECT SIZE

WIDTH	LENGTH	CODE	✓
10" 25cm	12" 30cm	1255-1012-OTS	<input type="radio"/>
	14" 35cm	1255-1014-OTS	<input type="radio"/>
	16" 40cm	1255-1016-OTS	<input type="radio"/>
11" 28cm	12" 30cm	1255-1112-OTS	<input type="radio"/>
	14" 35cm	1255-1114-OTS	<input type="radio"/>
	16" 40cm	1255-1116-OTS	<input type="radio"/>
12" 30cm	14" 35cm	1255-1214-OTS	<input type="radio"/>
	16" 40cm	1255-1216-OTS	<input type="radio"/>
	18" 45cm	1255-1218-OTS	<input type="radio"/>
13" 33cm	14" 35cm	1255-1314-OTS	<input type="radio"/>
	16" 40cm	1255-1316-OTS	<input type="radio"/>
	18" 45cm	1255-1318-OTS	<input type="radio"/>
14" 35cm	16" 40cm	1255-1416-OTS	<input type="radio"/>
	18" 45cm	1255-1418-OTS	<input type="radio"/>
	20" 50cm	1255-1420-OTS	<input type="radio"/>
15" 38cm	16" 40cm	1255-1516-OTS	<input type="radio"/>
	18" 45cm	1255-1518-OTS	<input type="radio"/>
	20" 50cm	1255-1520-OTS	<input type="radio"/>
16" 40cm	18" 45cm	1255-1618-OTS	<input type="radio"/>
	20" 50cm	1255-1620-OTS	<input type="radio"/>
	23" 58cm	1255-1623-OTS	<input type="radio"/>
17" 43cm	18" 45cm	1255-1718-OTS	<input type="radio"/>
	20" 50cm	1255-1720-OTS	<input type="radio"/>
	23" 58cm	1255-1723-OTS	<input type="radio"/>
18" 45cm	18" 45cm	1255-1818-OTS	<input type="radio"/>
	20" 50cm	1255-1820-OTS	<input type="radio"/>
	23" 58cm	1255-1823-OTS	<input type="radio"/>
19" 48cm	18" 45cm	1255-1918-OTS	<input type="radio"/>
	20" 50cm	1255-1920-OTS	<input type="radio"/>
	23" 58cm	1255-1923-OTS	<input type="radio"/>
20" 50cm	18" 45cm	1255-2018-OTS	<input type="radio"/>
	20" 50cm	1255-2020-OTS	<input type="radio"/>
	23" 58cm	1255-2023-OTS	<input type="radio"/>

3. SELECT HARDWARE

Single Mount 1259-2100-100	Dual Mount 1259-2200-100	Quad Mount 1259-2400-100	Quad Mount, Heavy Duty, up to 23" wide 1259-2405-100
Quad Mount, Heavy Duty, 23" wide + 1259-2406-100	Direct Mount 1259-2460-100	Drop Mount <input type="radio"/> Paediatric: 1259-1400-00P <input type="radio"/> Small: 1259-1400-00S <input type="radio"/> Medium: 1259-1400-00M <input type="radio"/> Large: 1259-1400-00L	Quad Extension Brackets 1259-2450-100

4. ADD ACCESSORIES

Additional backrest lumber pad and lateral stability wedges 1209-2713-300	Asymmetric narrow contour wedge (200mm x 100mm x 40mm) 1209-2722-300	Asymmetric bi-angular contour wedge (200mm x 100mm x 40mm) 1209-2723-300
Asymmetric contour kit 1209-2720-300	Extra Outer Cover (A) Extra Incontinence Cover (B)	Extra Positioning Kit (pack 10 cubes) 1255-XXXX-300

Spex SuperShape Back Support

PACKAGE INCLUDES:

1. Aluminium Shell
2. Foam System
3. Outer Cover
4. Spare Pack of foam cubes including firm EVA Posterior Pelvic Support & Positioning Wedges

(Note: hardware must be selected)



1256-WWDD-OSS

1. SELECT SIZING

To order replace **WW** and **HH** in code

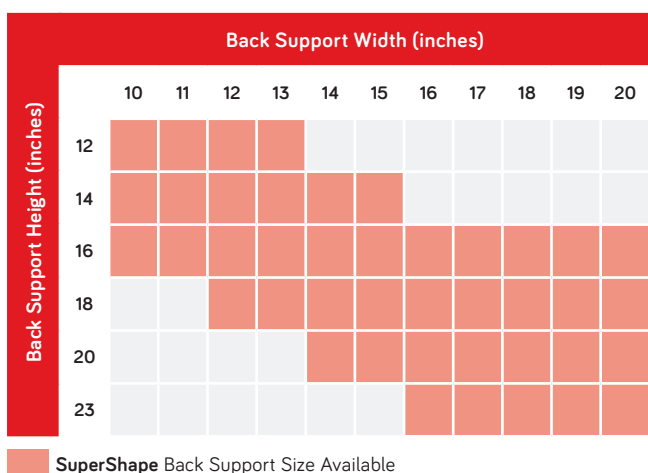

2. SELECT COLOUR

Your colour selection applies to any extra covers ordered

Black (default) 1209-2491-000	Chilli 1209-2491-022	Mango 1209-2491-030
Bumblebee 1209-2491-044	Calypso 1209-2491-028	Royal 1209-2491-077
Ocean 1209-2491-060	Leaf 1209-2491-054	Granite 1209-2491-090

3. SELECT HARDWARE

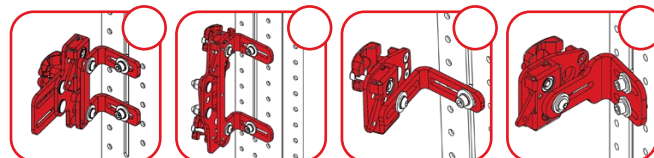

- Single Mount**
1259-2100-100
- Dual Mount**
1259-2200-100
- Quad Mount**
1259-2400-100
- Quad Mount, Heavy Duty, up to 23" wide**
1259-2405-100

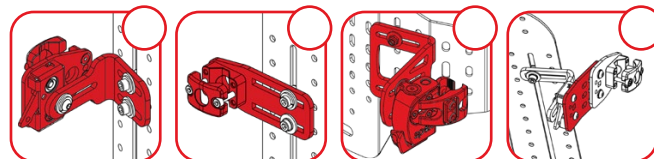

- Quad Mount, Heavy Duty, 23" wide +**
1259-2406-100
- Direct Mount**
1259-2460-100
- Drop Mount**
 - Paediatric: 1259-1400-00P
 - Small: 1259-1400-00S
 - Medium: 1259-1400-00M
 - Large: 1259-1400-00L
- Quad Extension Brackets**
1259-2450-100

4. ADD ACCESSORIES

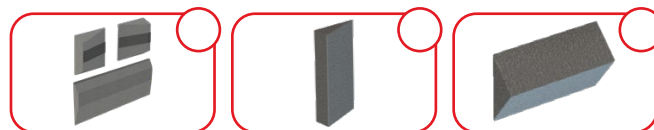

- Additional backrest lumber pad and lateral stability wedges**
1209-2713-300
- Asymmetric narrow contour wedge (200mm x 100mm x 40mm)**
1209-2722-300
- Asymmetric bi-angular contour wedge (200mm x 100mm x 40mm)**
1209-2723-300



- Asymmetric contour kit**
1209-2720-300
- Extra Outer Cover (A) Extra Incontinence Cover (B)**
- Extra Positioning Kit (pack 10 cubes)**
1255-XXXX-300

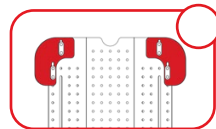

- T-shape modification**
1209-2933-000

5. BUILD CODE

REFER TO THE SUPERSHAPE BACK SUPPORT CODES ABOVE

1 2 5 6 - [] [] [] [] - 0 S S

ADD WIDTH ADD HEIGHT

XLella Back Support

1. SELECT BACK SUPPORT



XLella, Vigour Padding
1258-WWHH-00H



XLella, Classic Padding
1258-WWHH-OSS



XLella2, Biangular
1258-WWHH-200

2. SELECT SIZING

To order replace
WW and HH in code

		Wheelchair Width (inches)					
		20	22	24	26	28	30
Back Support Height (inches)	12						
	13						
	14						
	15						
	16						
	17						
	18						
	19						
	20						
	21						
	22						
23							
24							
25							

XLella Vigour or Classic
 XLella[®] Biangular

3. SELECT COLOUR

Your colour selection applies to
any extra covers ordered

Black (default)	Chilli 1209-2491-022	Mango 1209-2491-030
Bumblebee 1209-2491-044	Calypso 1209-2491-028	Royal 1209-2491-077
Ocean 1209-2491-060	Leaf 1209-2491-054	Granite 1209-2491-090

4. SELECT HARDWARE - FOR XLELLA

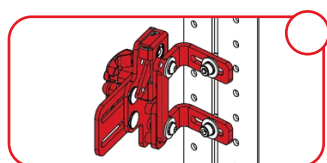

Fixed Bariatric Hardware (default)
1259-2500-100

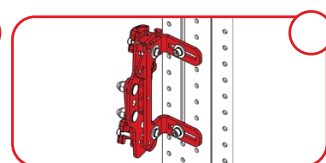

Quick-Release Bariatric Hardware
1259-2505-100

5. SELECT UPGRADES & ACCESSORIES

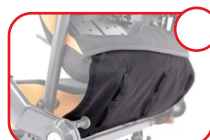

- Cover Extension**
- 22"
1258-2200-500
 - 24"
1258-2400-500
 - 26"
1258-2600-500
 - 28"
1258-2800-500

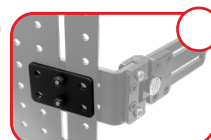

Reinforcement Plate for Lateral Supports
(forceful side leaning or users over 100kg)
1266-2450-100

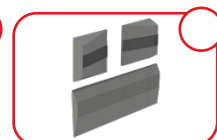

Additional backrest lumber pad and lateral stability wedges
1209-2713-300

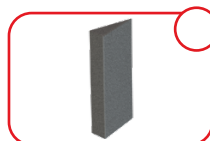

Asymmetric narrow contour wedge
(200mm x 100mm x 40mm)
1209-2722-300

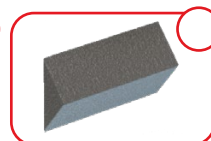

Asymmetric bi-angular contour wedge
(200mm x 100mm x 40mm)
1209-2723-300

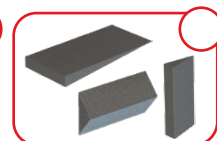

Asymmetric contour kit
1209-2720-300



Extra Outer Cover (A)
Extra Incontinence Cover (B)



Heavy-Duty kit for Stylo Head Support
1274-0000-HDK

6. BUILD CODE

REFER TO THE XLELLA BACK SUPPORT CODES ABOVE

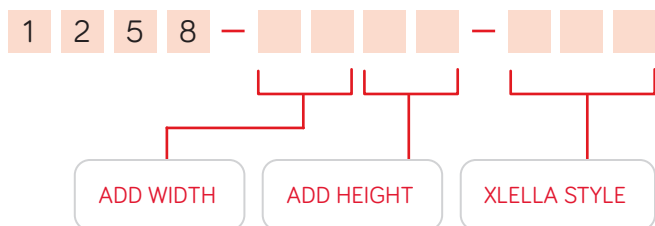

Back Support Custom Sizes

1. SELECT BACK SUPPORT

(cover & back support can be selected simultaneously)

UP TO 20"

	COVER	BACK SUPPORT
Custom Vigour	<input type="radio"/>	<input type="radio"/>
Vigour	<input type="radio"/>	<input type="radio"/>
Custom Manta	<input type="radio"/>	<input type="radio"/>
Adapta	<input type="radio"/>	<input type="radio"/>
Custom Comfi	<input type="radio"/>	<input type="radio"/>
Custom Spex Classic	<input type="radio"/>	<input type="radio"/>
Custom Spex T-Shape	<input type="radio"/>	<input type="radio"/>
Spex Growth-Adjust	<input type="radio"/>	<input type="radio"/>
Spex Supershape	<input type="radio"/>	<input type="radio"/>
Xlella Vigour	<input type="radio"/>	<input type="radio"/>
Xlella Classic	<input type="radio"/>	<input type="radio"/>
Xlella ²	<input type="radio"/>	<input type="radio"/>

UP TO 25"

SIZES ABOVE 21", REFER XLELLA

	COVER	BACK SUPPORT
<input type="radio"/>	<input type="radio"/>	<input type="radio"/>
<input type="radio"/>	<input type="radio"/>	<input type="radio"/>
<input type="radio"/>	<input type="radio"/>	<input type="radio"/>
<input type="radio"/>	<input type="radio"/>	<input type="radio"/>
<input type="radio"/>	<input type="radio"/>	<input type="radio"/>
<input type="radio"/>	<input type="radio"/>	<input type="radio"/>
<input type="radio"/>	<input type="radio"/>	<input type="radio"/>
<input type="radio"/>	<input type="radio"/>	<input type="radio"/>
<input type="radio"/>	<input type="radio"/>	<input type="radio"/>
<input type="radio"/>	<input type="radio"/>	<input type="radio"/>
<input type="radio"/>	<input type="radio"/>	<input type="radio"/>
<input type="radio"/>	<input type="radio"/>	<input type="radio"/>

SIZES ABOVE 21", REFER XLELLA

IMPORTANT

When ordering custom size back supports, lead time can be extended by up to 12 working days.

2. ENTER MEASUREMENTS

1

WHEELCHAIR WIDTH XX
1 = ____

2

SHELL HEIGHT XX
2 = ____

3

For standard mounting using Single/Dual/Quad mounts the distance between edge of shell and inside of cane needs to be a minimum of 20mm and maximum of 45mm (each side).

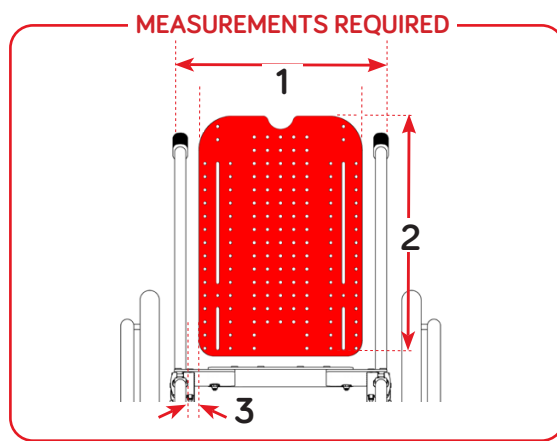

3. SPECIFY PADDING

Default Padding
(wheelchair width -1", for XLella backs, wheelchair width +1")
Default

Default

Slim Fit Padding
(same width as shell)
1249-2339-300

1249-2339-300

Custom Fit Padding
1249-2349-30

1249-2349-300

LENGTH L = ____

WIDTH W = ____

Back Support Accessories

TESSELLATED SHAPE SYSTEM KIT

WIDTH	HEIGHT		ITEM CODE	✓
10" 25cm	12"	30cm	1250-1012-000	<input type="radio"/>
	14"	35cm	1250-1014-000	<input type="radio"/>
	16"	40cm	1250-1016-000	<input type="radio"/>
12" 30cm	14"	35cm	1250-1214-000	<input type="radio"/>
	16"	40cm	1250-1216-000	<input type="radio"/>
	18"	45cm	1250-1218-000	<input type="radio"/>
14" 35cm	16"	40cm	1250-1416-000	<input type="radio"/>
	18"	45cm	1250-1418-000	<input type="radio"/>
	20"	50cm	1250-1420-000	<input type="radio"/>
16" 40cm	18"	45cm	1250-1618-000	<input type="radio"/>
	20"	50cm	1250-1620-000	<input type="radio"/>
	23"	58cm	1250-1623-000	<input type="radio"/>
18" 45cm	18"	45cm	1250-1818-000	<input type="radio"/>
	20"	50cm	1250-1820-000	<input type="radio"/>
	23"	58cm	1250-1823-000	<input type="radio"/>
20" 50cm	18"	45cm	1250-2018-000	<input type="radio"/>
	20"	50cm	1250-2020-000	<input type="radio"/>
	23"	58cm	1250-2023-000	<input type="radio"/>
Up to 20" (50cm)	XX	XX	1250-2929-000	<input type="radio"/>
Up to 25" (63cm)	XX	XX	1250-2939-000	<input type="radio"/>
TSS to suit back ordered on Script (inc. shape mods)			1250-3949-000	<input type="radio"/>

STANDARD TESSELLATED SHAPE SYSTEM KIT



ELEMENTS BUILDING KIT ONLY

TSS Elements building kit only (no backboard). Use when mounting shape elements directly to back shell. 1250-3959-000



EXTRA POSITIONING WEDGES

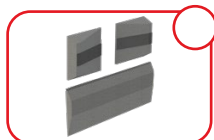

Additional backrest lumber pad and lateral stability wedges
1209-2713-300

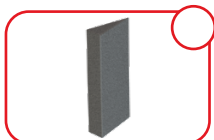

Asymmetric narrow contour wedge (20cm x 10cm x 4cm)
1209-2722-300

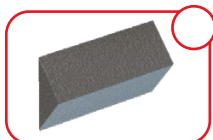

Asymmetric bi-angular contour wedge (20cm x 10cm x 4cm)
1209-2723-300

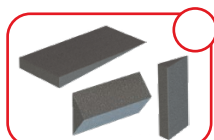

Asymmetric contour kit
1209-2720-300

EXTRA HARDWARE

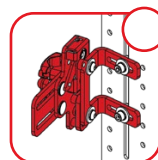

Single Mount for second wheelchair
1259-2120-100

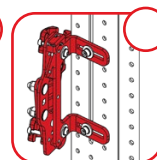

Dual Mount for second wheelchair
1259-2220-100

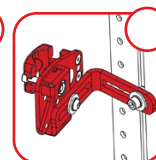

Quad Mount for second wheelchair
1259-2420-100

ALTERNATIVE MOUNTING OPTIONS

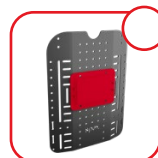

Spex Power Recline Adapter Mount
1259-2810-200

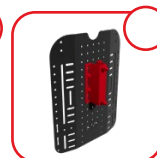

Spex Standing Powerchair Adapter Mount
1259-2610-200

SUPRACOR® HONEYCOMB

Envelope Cover only for Supracor® insert
1208-2951-300

Envelope Cover with Supracor insert
1208-2952-300

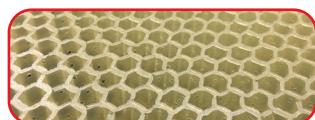

Supracor Honeycomb covers add 13mm to cushion height and provide heat & sweat reduction.

Supracor Honeycomb covers must be ordered with back support or spare cover.

Lateral Trunk Support

1. SELECT HARDWARE

(Laterals are scripted as each, not in pairs)

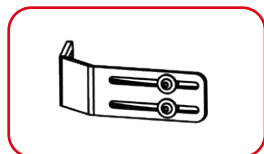

Fixed Hardware

- Fixed Bracket: 1266-2101-100
- Paediatric Fixed Bracket: 1266-2111-100

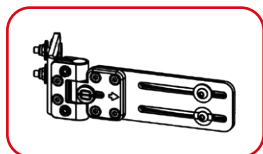

Swing Away Hardware

- Straight: 1266-2203-100
- Extended Straight: 1266-2202-100

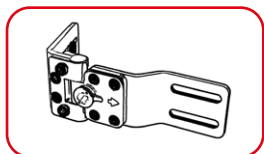

Offset Swing Away Hardware

- Offset: 1266-2101-100
- Extended Offset: 1266-2204-100

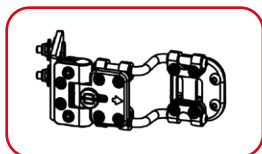

Axial Swing Away Hardware

- Axial: 1266-2301-100
- Depth-Reduced Axial: 1266-2331-100
- Paediatric Axial Lateral: 1266-2613-100-[L/R]
- Paediatric Swing Away Cane Mount: 1266-2623-400
- Paediatric Swing Away Cane Mount: 1266-2623-300-L/R
- Paediatric Axial Forward Mount: 1266-2623-200-L/R

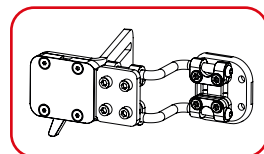

Quick-Release

- Back Mount Fixed Angle: 1266-2601-100-L/R
- Cane Mount Fixed Angle: 1266-2601-200-L/R
- Back Mount, Swing-Away, Angle Adjustment: 1266-2621-100-L/R
- Cane Mount, Swing-Away, Angle Adjustment: 1266-2621-200-L/R

2. SELECT PAD & SIZE

NARROW STRAIGHT



SIZES AVAILABLE

- 0 (85mm x 115mm) -XX10-
- 1 (95mm x 145mm) -XX11-
- 2 (95mm x 180mm) -XX12-
- 3 (115mm x 210mm) -XX13-
- 4 (115mm x 240mm) -XX14-

SELECT

- L R
- L R
- L R
- L R
- L R

NARROW CURVED



SIZES AVAILABLE

- 1 (95mm x 145mm) -XX21-
- 2 (95mm x 180mm) -XX22-
- 3 (115mm x 210mm) -XX23-
- 4 (115mm x 240mm) -XX24-

SELECT

- L R
- L R
- L R
- L R

BROAD



SIZES AVAILABLE

- 1 (105mm x 130mm) -XX31-
- 2 (125mm x 140mm) -XX32-
- 3 (140mm x 150mm) -XX33-
- 4 (160mm x 155mm) -XX34-
- 5 (195mm x 165mm) -XX35-
- 6 (230mm x 175mm) -XX36-

SELECT

- L R
- L R
- L R
- L R
- L R
- L R

3. SELECT COVER



Standard (-400)



Comfi (-800)

Incompatible with Quick-Release

4. CUSTOMISE



Left Cane Mount
(attachment directly to wheelchair canes)
1266-2411-100



Right Cane Mount
(attachment directly to wheelchair canes)
1266-2412-100

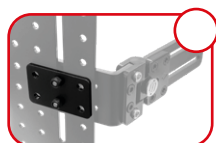

Reinforcement plate
(forceful side leaning or clients over 100kg)
1266-2450-100

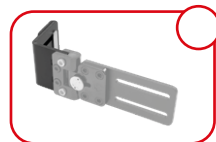

Deep Contour Bracket
(extends depth by 30mm)
1266-2420-100



Deep Contour Extended Bracket Kit
(extends depth up to 115mm)
1266-2430-100

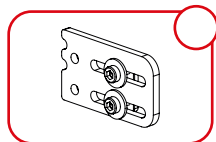

Extender Kit for Paediatric Swing-Away Lateral
(extends depth up to 40mm)
1266-2440-100

5. BUILD CODE FOR LATERAL PAD

REFER TO THE LATERAL TRUNK SUPPORT CODES ABOVE

1 2 6 6 - 3 0 - - -

ADD PAD CODES

ADD COVER CODES

Axial Biangular Lateral Trunk Support

1. SELECT HARDWARE

(Laterals are scripted as each, not in pairs)

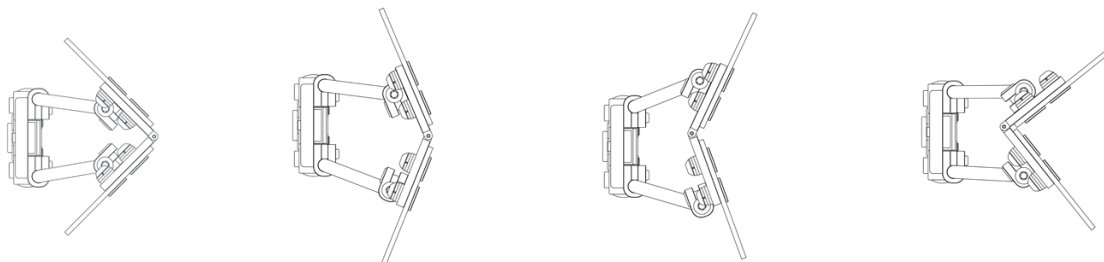

2. SELECT BIANGULAR PAD SIZE

AXIAL PAD

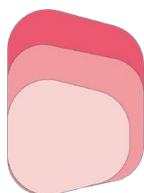

SIZES AVAILABLE

4 (165mm x 175mm)

-XX44-

6 (215mm x 195mm)

-XX46-

8 (265mm x 195mm)

-XX48-

SELECT

L

R

L

R

L

R

5. CUSTOMISE



Left Cane Mount
(attachment directly to wheelchair canes)
1266-2411-100



Right Cane Mount
(attachment directly to wheelchair canes)
1266-2412-100

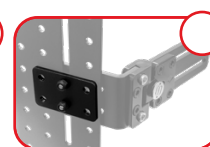

Reinforcement plate
(forceful side leaning or clients over 100kg)
1266-2450-100



Deep Contour Bracket
(extends depth by 30mm)
1266-2420-100



Deep Contour Extended Bracket Kit
(extends depth up to 115mm)
1266-2430-100

3. SELECT PADDING

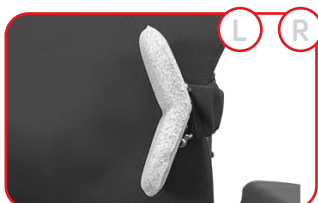

12mm Pressure-Reduction
Overall Pad Thickness 30mm
-X00

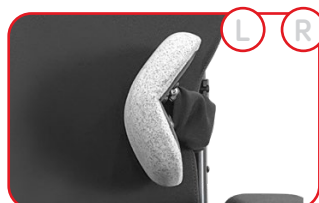

24mm Pressure-Reduction
Overall Pad Thickness 45mm
-X10

4. SELECT COVER



Standard (-4XX)



Comfi (-8XX)

6. BUILD CODE FOR LATERAL PAD

REFER TO THE LATERAL TRUNK SUPPORT CODES ABOVE

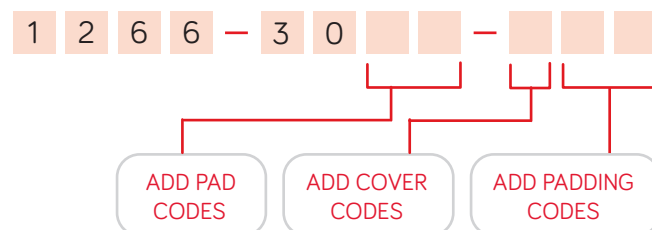

Arm Supports

1. SELECT ARM SUPPORT HARDWARE

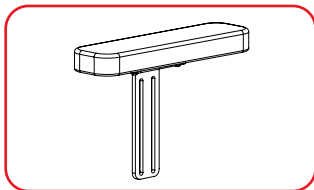

- Fixed -01XX-
- Fixed Paediatric -02XX-

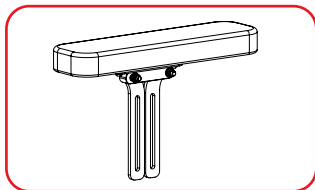

- Angle Adjust -03XX-

2. SELECT ARM SUPPORT MOUNTING

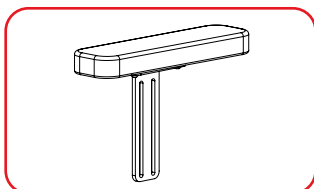

- Seat Rail -2XX-

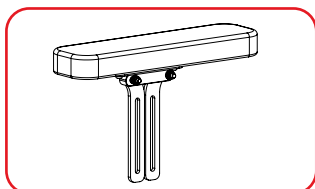

- Seat Pan -1XX-

3. SELECT ARM SUPPORT MECHANISM

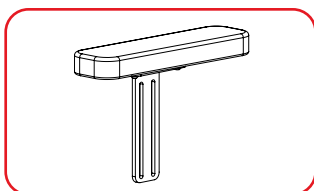

- Quick Release -X1X-

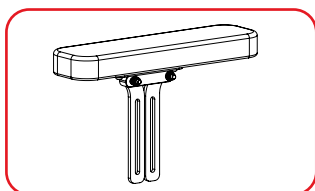

- Swing-Down -X2X-

4. SELECT COMFI ARM SUPPORT PADS



SIZES AVAILABLE

1 NARROW	1156-5811-410	40mm x 250mm	<input type="radio"/>
2 NARROW	1156-5812-410	50mm x 300mm	<input type="radio"/>
3 NARROW	1156-5813-410	60mm x 350mm	<input type="radio"/>
1 WIDE	1156-5821-410	70mm x 250mm	<input type="radio"/>
2 WIDE	1156-5822-410	80mm x 300mm	<input type="radio"/>
3 WIDE	1156-5823-410	90mm x 350mm	<input type="radio"/>

CUSTOM

1156-5829-410 ^{XX} A = ____ ^{XX} B = ____

5. CUSTOMISE

(tick any customisations that apply)

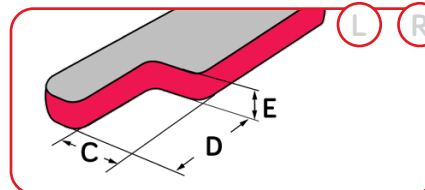

Controller Cutout
1300-5839-400

^{XX} C = ____ D = ____

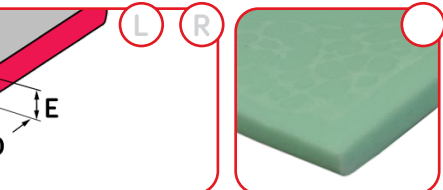

Custom Thickness
1300-5842-400

^{XX} E = ____

½" Gel-Foam overlay
(custom fabric on arm support pad)
1300-5847-400



Spetex waterproof cover
(knitted fabric surface)
1300-5849-219

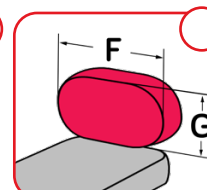

Rear elbow pad & bracket
1300-5844-400

^{XX} F = ____ G = ____

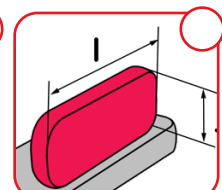

Side elbow pad
1300-5845-400

^{XX} I = ____ J = ____

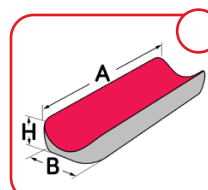

Arm troughing
1300-5835-400

^{XX} A = ____ B = ____
^{XX} H = ____

6. BUILD CODE

REFER TO THE ARM SUPPORT CODES ABOVE

1 1 5 6 - [] [] 0 0 - [] [] 0

ADD HARDWARE CODES

ADD MOUNTING CODES

ADD MECHANISM CODES

Thigh Supports

1. SELECT THIGH SUPPORT HARDWARE

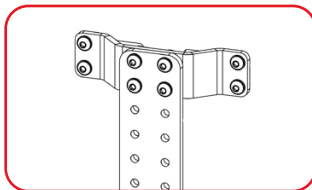

Fixed
-0002-

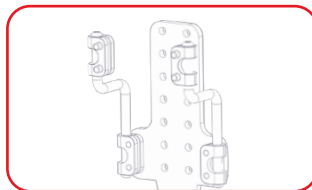

Axial
-0001-

2. SELECT THIGH SUPPORT MOUNTING

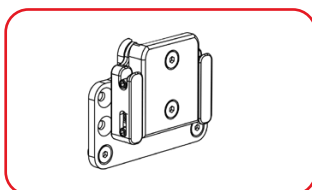

Seat Rail
-2XX-

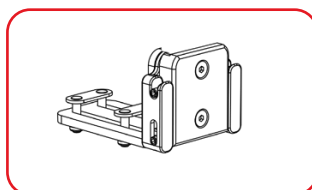

Seat Pan
-1XX-

3. SELECT THIGH SUPPORT MECHANISM



Quick Release
-X1X-



Swing-Down
-X2X-

4. SELECT COMFI THIGH SUPPORT PADS



SIZES AVAILABLE

- | | | | |
|------------|---------------|------------------|-----------------------|
| 10" (25cm) | 1156-1010-400 | 90 x 265 x 35mm | <input type="radio"/> |
| 12" (30cm) | 1156-1012-400 | 95 x 310 x 35mm | <input type="radio"/> |
| 14" (35cm) | 1156-1014-400 | 130 x 360 x 35mm | <input type="radio"/> |
| 16" (40cm) | 1156-1016-400 | 135 x 410 x 35mm | <input type="radio"/> |
| 18" (45cm) | 1156-1018-400 | 145 x 460 x 35mm | <input type="radio"/> |
| 20" (50cm) | 1156-1020-400 | 160 x 510 x 35mm | <input type="radio"/> |

CUSTOM

1156-1029-400 A=XX B=XX E=XX

5. CUSTOMISE

(tick any customisations that apply)

SELECT	ITEM	IMAGE
<input type="radio"/> L <input type="radio"/> R	Custom Cut-out 1153-1139-400 C=XX D=XX C=____ D=____	
<input type="radio"/>	Custom Thickness 1153-1145-400 E=XX E=____	
<input type="radio"/>	1/2" Gel-Foam overlay (custom fabric on thigh support pad) 1153-1147-400	
<input type="radio"/>	Spextex waterproof cover (wipe-down surface) 1153-1149-209	
<input type="radio"/>	Spextex waterproof cover (knitted fabric surface) 1153-1149-219	

6. BUILD CODE

REFER TO THE THIGH SUPPORT CODES ABOVE

1 1 5 6 - [] [] [] [] - [] [] 0

ADD HARDWARE CODES

ADD MOUNTING CODES

ADD MECHANISM CODES

Combo Arm/Thigh Hardware

CONFIGURATION EXAMPLES



Angle Adjust Arm + Axial Thigh with Seat Rail Mount



Angle Adjust Arm + Axial Thigh with Seat Pan Mount

1. SELECT SEAT PAN MOUNTING

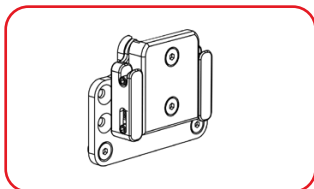

Seat Rail
-2XX-

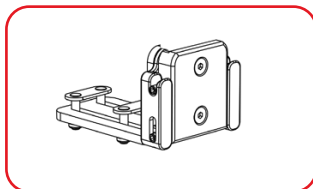

Seat Pan
-1XX-

2. SELECT MECHANISM



Quick Release
-X1X-



Swing-Down
-X2X-

3. SELECT CONFIGURATION

SIZES AVAILABLE

ANGLE-ADJUST ARM + AXIAL THIGH	XXXX-0301-XXX	<input type="radio"/>
ANGLE-ADJUST ARM + FIXED THIGH	XXXX-0302-XXX	<input type="radio"/>
FIXED ARM + AXIAL THIGH	XXXX-0101-XXX	<input type="radio"/>
PAEDIATRIC FIXED ARM + AXIAL THIGH	XXXX-0201-XXX	<input type="radio"/>
FIXED ARM + FIXED THIGH	XXXX-0102-XXX	<input type="radio"/>
PAEDIATRIC FIXED ARM + FIXED THIGH	XXXX-0202-XXX	<input type="radio"/>

4. SELECT COMFI ARM SUPPORT PADS



SIZES AVAILABLE

1 NARROW	1156-5811-410	40mm x 250mm	<input type="radio"/>
2 NARROW	1156-5812-410	50mm x 300mm	<input type="radio"/>
3 NARROW	1156-5813-410	60mm x 350mm	<input type="radio"/>
1 WIDE	1156-5821-410	70mm x 250mm	<input type="radio"/>
2 WIDE	1156-5822-410	80mm x 300mm	<input type="radio"/>
3 WIDE	1156-5823-410	90mm x 350mm	<input type="radio"/>

CUSTOM

1156-5829-410 A = B =

5. SELECT COMFI THIGH SUPPORT PADS



SIZES AVAILABLE

10" (25cm)	1156-1010-400	90 x 265 x 35mm	<input type="radio"/>
12" (30cm)	1156-1012-400	95 x 310 x 35mm	<input type="radio"/>
14" (35cm)	1156-1014-400	130 x 360 x 35mm	<input type="radio"/>
16" (40cm)	1156-1016-400	135 x 410 x 35mm	<input type="radio"/>
18" (45cm)	1156-1018-400	145 x 460 x 35mm	<input type="radio"/>
20" (50cm)	1156-1020-400	160 x 510 x 35mm	<input type="radio"/>

CUSTOM

1156-1029-400 A = B = E =

6. BUILD CODE

REFER TO THE ARM/THIGH SUPPORT CODES ABOVE

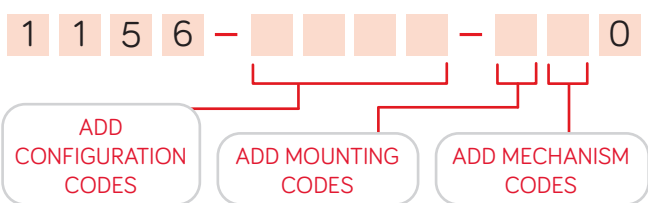

Medial Thigh Support

1. SELECT HARDWARE



Standard
-150X-



Axial
-160X-

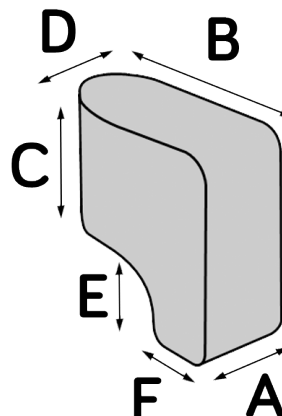

2. SELECT MEDIAL THIGH SUPPORT SIZE

STANDARD PAD

<input type="radio"/>	SIZE 1	XXXX-1501-XXX	A = 60mm	B = 145mm	C = 95mm	D = 40mm	E = 40mm	F = 65mm
<input type="radio"/>	SIZE 2	XXXX-1502-XXX	A = 60mm	B = 155mm	C = 100mm	D = 60mm	E = 50mm	F = 65mm
<input type="radio"/>	SIZE 3	XXXX-1503-XXX	A = 60mm	B = 185mm	C = 105mm	D = 60mm	E = 60mm	F = 75mm
<input type="radio"/>	CUSTOM	XXXX-1509-XXX	A = ____	B = ____	C = ____	D = ____	E = ____	F = ____

AXIAL ADJUSTABLE PAD

<input type="radio"/>	SIZE 1	XXXX-1601-XXX	A = 70-140mm	B = 145mm	C = 95mm	D = 50-120mm	E = 40mm	F = 65mm
<input type="radio"/>	SIZE 2	XXXX-1602-XXX	A = 70-140mm	B = 155mm	C = 100mm	D = 60-140mm	E = 50mm	F = 65mm
<input type="radio"/>	SIZE 3	XXXX-1603-XXX	A = 70-160mm	B = 185mm	C = 105mm	D = 60-140mm	E = 60mm	F = 75mm
<input type="radio"/>	CUSTOM	XXXX-1609-XXX	A = ____	B = ____	C = ____	D = ____	E = ____	F = ____

3. CUSTOMISE

(tick any customisations that apply)

SELECT	ITEM	IMAGE
<input type="radio"/>	½" Pressure Relieving foam overlay (Custom fabric on medial thigh support cover) 1160-1576-000	
<input type="radio"/>	½" Gel-Foam overlay (Custom fabric on medial thigh support cover) 1153-1147-400	
<input type="radio"/>	Spextex waterproof cover (Wipe-down surface) 1153-1149-209	
<input type="radio"/>	Spextex waterproof cover (Knitted fabric surface) 1153-1149-209	

4. BUILD CODE

REFER TO THE MEDIAL THIGH SUPPORT CODES ABOVE

1 1 6 2 - [] [] [] [] - 0 0 0

ADD HARDWARE CODES

ADD SIZE CODES

Stylo Head Support

1. SELECT HARDWARE



Stylo 130
1274-1232-000



Stylo 160
1274-1252-000



Stylo 260
1274-1282-000

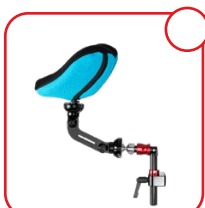

Stylo Flip-Back 160
1274-2252-000

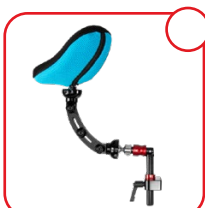

Stylo Flip-Back 260
1274-2282-000

2. SELECT PAD & SIZE

(Width x Height x Depth)

COMFORT

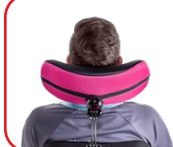

250

1275-0031-000

260mm x 125mm
x 90mm

350

1275-0032-000

340mm x 165mm
x 120mm

CIRCLE



150

1275-0011-000

175mm x 145mm
x 55mm

250

1275-0012-000

220mm x 185mm
x 70mm

CONTOUR



250

1275-0021-000

280mm x 165mm
x 140mm

350

1275-0022-000

350mm x 210mm
x 170mm

ADJUSTABLE LATERAL



150

1275-0061-000

175mm x 145mm
x 55mm

250

1275-0062-000

220mm x 185mm
x 70 mm

STANDARD AND EXTENDED LATERAL

STANDARD



Standard
Paediatric

1275-0041-000

220mm x 150mm
x 145mm

Standard

1275-0043-000

250mm x 170mm
x 180mm

EXTENDED



Extended
Paediatric

1275-0042-000

230mm x 180mm
x 160mm

Extended

1275-0044-000

260mm x 190mm
x 180mm

3. SELECT COLOUR

Your colour selection applies to any extra covers ordered

Black
(default)

Chilli
1209-2491-022

Mango
1209-2491-030

Bumblebee
1209-2491-044

Calypso
1209-2491-028

Royal
1209-2491-077

Ocean
1209-2491-060

Leaf
1209-2491-054

Granite
1209-2491-090

4. CUSTOMISE



1/2" soft pressure-relieving foam overlay
1271-0019-000

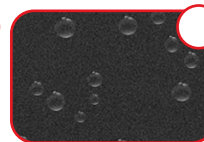

Spextex waterproof cover - wipe-down surface
1271-0039-209



Spextex waterproof cover - knitted fabric surface
1271-0039-219



Neoprene cover
1271-0039-291



Stylo Heavy-Duty Compatibility Kit
(Allows attachment to other backs and reinforces connection, reducing shell flex and ball slip)
1274-0000-HDK



Stylo Slim Mount
(For use where space is limited, e.g. power wheelchairs)
1274-4140-200

CUSTOMISE (ADJUSTABLE LATERAL HEADREST ONLY)

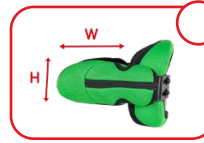

Custom wing headrest pads
1270-4149-300

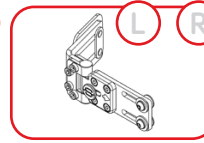

Swing-away lateral mech upgrade
1272-4250-100

L = ___ H = ___

Harnesses

1. SELECT HARNESS

Tick option that applies

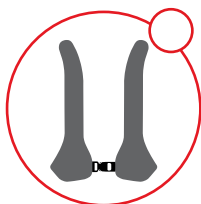

H-HARNESS
-664X-

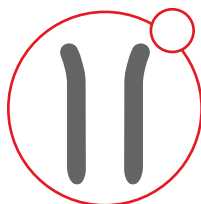

RETRACTOR
-662X-



VEST
-661X-

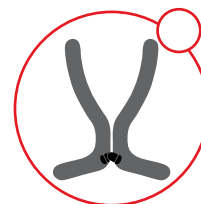

CENTREPOINT
-666X-

2. SELECT SIZE

XS X-Small -XXX0-	S Small -XXX1-	M Medium -XXX2-	L Large -XXX3-	XL X-Large -XXX4-
--------------------------------	-----------------------------	------------------------------	-----------------------------	--------------------------------

3. CUSTOMISE

(tick any customisations that apply)

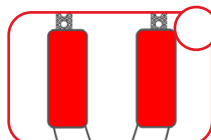

Removable neoprene sleeves
1409-6810-000
- XX -
L = ____

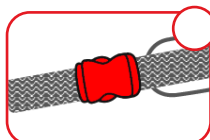

Buckles
(Fitted to lower shoulder harness straps)
1409-6820-000

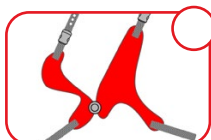

Custom shape alteration
(More information required with order)
1409-6834-000

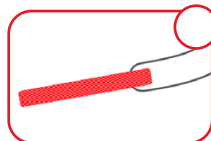

Extra-long webbing straps
1409-6815-000
- XX -
L = ____



Change buckle to centre-release style
(H-Harness & Centrepoint only)
1409-6828-000

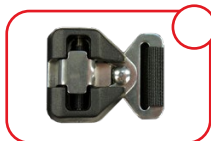

Change buckle to anti-escape style
1409-6826-000

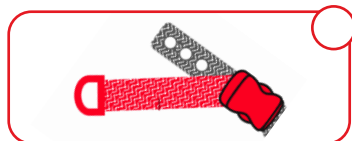

Convert shoulder harness to rear-pull style
1409-6841-000

4. SELECT ACCESSORIES



Shoulder Strap Guides
(Attachment Hardware Included)
1400-6692-000

5. BUILD CODE

REFER TO THE HARNESS CODES ABOVE

1 4 0 9 - [] [] [] - 0 1 7

ADD HARNESS CODES

ADD SIZE CODES

IMPORTANT

- S, M, L & XL available only for retractor harness.
- XS, S, M & L available only for vest harness.

Chest Straps

SELECT SIZE



- **Small**
(35cm W x 7.5cm H)
1409-6821-017
- **Medium**
(40cm W x 8cm H)
1409-6822-017
- **Large**
(55cm W x 10cm H)
1409-6823-017

Hip Belts

1. SELECT HIP BELT

Tick option that applies



✓	SIZE	2 POINT CENTRE PULL	2 POINT DUAL CENTRE PULL	4 POINT SIDE PULL	4 POINT CENTRE PULL	4 POINT DUAL CENTRE PULL
<input type="radio"/>	X-SMALL	XXX5-6210-XXX	XXX5-6220-XXX	XXX6-6400-XXX	XXX6-6410-XXX	XXX6-6420-027
<input type="radio"/>	SMALL	XXX5-6211-XXX	XXX5-6221-XXX	XXX6-6401-XXX	XXX6-6411-XXX	XXX6-6421-027
<input type="radio"/>	MEDIUM	XXX5-6212-XXX	XXX5-6222-XXX	XXX6-6402-XXX	XXX6-6412-XXX	XXX6-6422-027
<input type="radio"/>	LARGE	XXX5-6213-XXX	XXX5-6223-XXX	XXX6-6403-XXX	XXX6-6413-XXX	XXX6-6423-027

2. SELECT BUCKLE

Tick option that applies



SIDE RELEASE
-027



CENTRE RELEASE
-028



ANTI-ESCAPE
-026



PEN-POPPER
-025

3. SELECT OPTIONAL ADD-ON

Pressure reducing gel-foam slip on sleeves for all hip belts. Retrofits to hip belt pads.

1409-6812-000



4. BUILD CODE

REFER TO THE HIP BELT & BUCKLE CODES ABOVE

1 4 0 [] - [] [] [] [] [] - [] [] []

ADD HIP BELT CODES

ADD BUCKLE CODES

IMPORTANT

- The 4 point dual centre-pull can only be used with the side release buckle.
- The 2 point dual centre-pull can only be used with the side release buckle.
- The anti-escape buckle is not available for x-small hip belts.

Limb Supports

PADDED FOREARM STRAPS

SIZE	SET OF FOUR	✓	ONE ONLY	QTY
SMALL	1408-6511-017	○	1408-6521-017	
MEDIUM	1408-6512-017	○	1408-6522-017	
LARGE	1408-6513-017	○	1408-6523-017	

PADDED FOREARM STRAPS



HEEL LOOPS

SIZE	LENGTH	PAIR	✓
SMALL	230mm	1403-6181-017	○
MEDIUM	255mm	1403-6182-017	○
LARGE	275mm	1403-6183-017	○

HEEL LOOPS



FOOTFAST STABILISERS

SIZE	CIRCUMFERENCE	STANDARD PAIR	✓	WITH REAR RETAINER STRAP	✓
SMALL	15-23cm (Inner)	1401-6161-017	○	1401-6165-017	○
MEDIUM	22-30cm (Inner)	1401-6162-017	○	1401-6166-017	○
LARGE	26-38cm (Inner)	1401-6163-017	○	1401-6167-017	○

FOOTFAST STABILISERS



REAR RETAINER STRAP



COMFORT PADDED & NEOPRENE CALF STRAPS

W/C WIDTH	HEIGHT	COMFORT PADDED CODE	✓	NEOPRENE CODE	✓
10"	5cm	1402-6170-017	○	1402-6070-017	○
12"	5cm	1402-6171-017	○	1402-6071-017	○
14"	7cm	1402-6172-017	○	1402-6072-017	○
16"	9cm	1402-6173-017	○	1402-6073-017	○
17"	9cm	1402-6174-017	○	1402-6074-017	○
18"	11cm	1402-6175-017	○	1402-6075-017	○
20"	13cm	1402-6176-017	○	1402-6076-017	○
XX	XX	1402-6177-017	○	1402-6077-017	○

PADDED CALF STRAPS



NEOPRENE CALF STRAPS



CALF PANELS

W/C WIDTH	WIDTH	HEIGHT	CODE	✓
14-15"	14"	8"	1402-6314-017	○
16-17"	16"	8"	1402-6316-017	○
18-19"	18"	10"	1402-6318-017	○
20"	20"	10"	1402-6320-017	○
Custom	XX	XX	1402-6329-017	○

CALF PANELS



spex

Manufactured by Spex Ltd

solutions@spexseating.com

spexseating.com

